



Model CN-Q/SS4/CY-36D receptacle with yellow powder coat finish, door open. Shown with Model TQ/CY-2410 flat steel lid.

- **36 gallon capacity**
- **Welded Steel Fabrication**
- **Choice of color, lid, liner, and mounting options**
- **Includes adjustable levelers**

MOUNTING OPTIONS

Model M2/G Embedded Pedestal Mount:
elevated concrete embedded installation

Model M3/G Surface Pedestal Mount:
elevated base plate on concrete installation

CAN AND LINER OPTIONS

Model CNG-2310C: Regular-duty, 31 gal. capacity, galvanized steel can

Model CN/B-1827: 36 gal. capacity, heavy-duty, rigid plastic liner

Model CN-4132C: 30 gal. capacity, plastic liner

Model CNG-WHD32C: Federal Duty, 32 gal. capacity, galvanized steel can

SPECIFICATIONS:

- **Model CN-Q/SS4-36D Series** trash receptacle holders are designed to hold most commercially available 30 to 36 gal. garbage containers.
- Model CN-Q/SS4-36D trash receptacle holders are a single welded construction of evenly spaced vertical 1/8" thick x 2" wide steel straps. This square container features a flared top with a formed 1" dia. steel tube ring to provide strength. Base is a 10 ga. x 1-1/2" flanged steel ring reinforced with die-formed cross braces of 10 ga. x 2" steel bar which facilitates anchoring of receptacle holder to hard surfaces.
- The door includes a zinc-plated draw over center latch that can be padlocked closed (padlock is optional).
- **Optional:** Model PL-1 brass padlock to lock the door closed.
- Base ring supports liner 2" off the ground for longer useful life.
- **Standard:** Four threaded adjustable levelers are located inside the base of the receptacle.
- **Standard:** Receptacle holder has a black powder coat finish (indicated by "/CB" in model no., e.g. CN-R/SS4/CB-36D).
- **Optional:** Choice of powder coat colors. See Specification Bulletin #SPC-CO-001.
- **Optional:** Four 3/8" x 3" screw anchors (anchor kit #ANC2-4) for hard surface mounting.

LID OPTIONS

- **Model CN-PQD/◆-24 Series** Pilot Rock Plastic Dome Lid
- **Model TQ/◆-2410** Flat Steel Lid with 10" opening
- **Model TQ/◆-2410R** Flat Steel Lid with 10" opening and rain cover
- **Model TQ/◆-2410A** Flat Steel Lid with 10" opening, rain cover and ashtray
- **Model CN/B-1826** Flat Molded Plastic Lid with 10" center opening
 - ◆ Indicates choice of finish or color — Inquire for specific model options

RJ Thomas Mfg. Co., Inc.

PO Box 946 • Cherokee, IA 51012-0946 • PH: 712-225-5115 • 800-762-5002 • FAX: 712-225-5796

E-mail: pilotrock@rjthomas.com • Web Site: <https://www.pilotrock.com>

© 2022 RJ Thomas Mfg. Co., Inc. PILOT ROCK® Park Products is a registered trademark of RJ Thomas Mfg. Co., Inc.

DOOR CLOSED

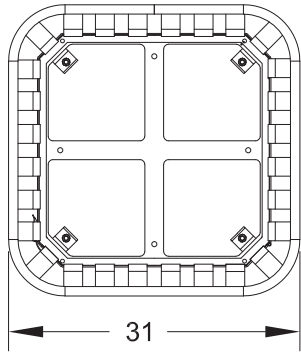

DOOR FULLY OPEN

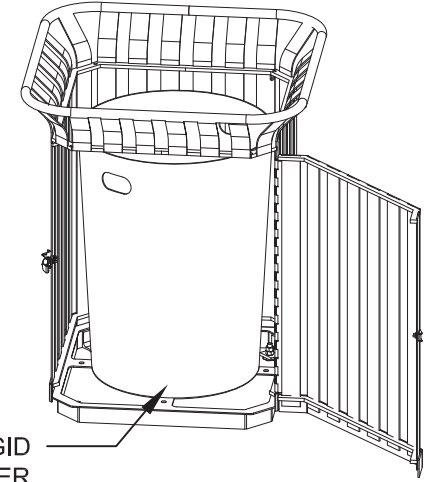
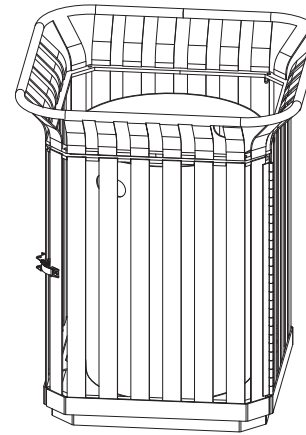
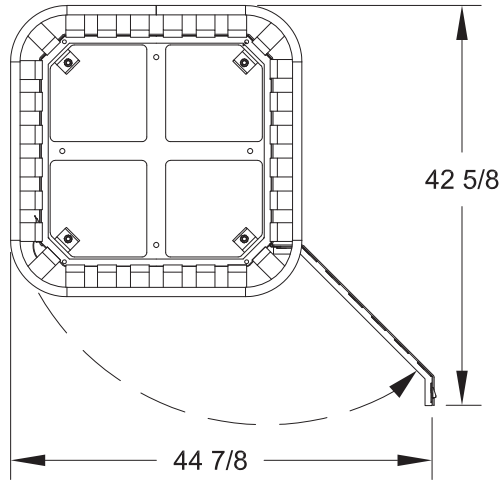

OPTIONAL RIGID
PLASTIC LINER

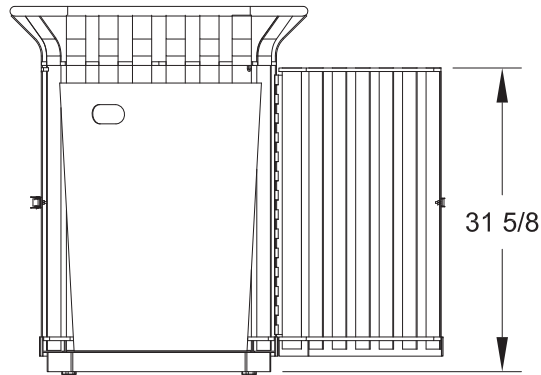
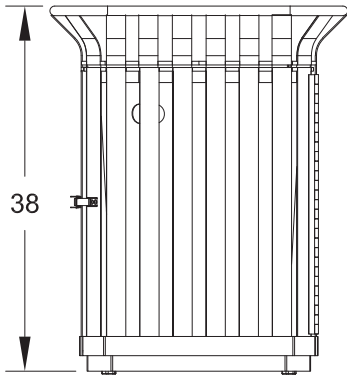

FRONT

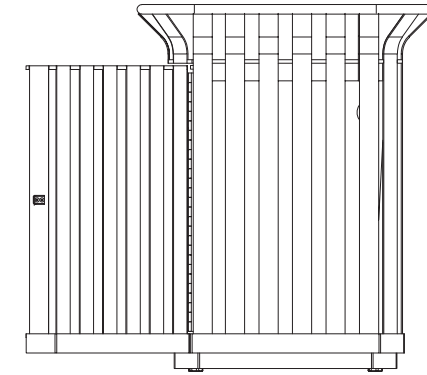
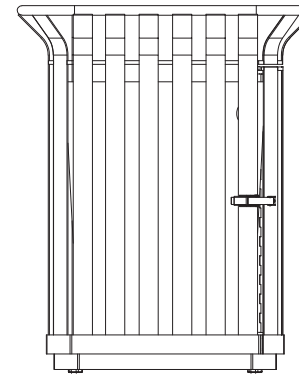

SIDE

ALL DIMENSIONS IN INCHES

RJThomas Mfg. Co., Inc.
 P.O. Box 946 • Cherokee, IA 51012-0946

DRAWN BY
JGJ

TITLE Model CN-Q/SS4-36D SQUARE STEEL STRAP TRASH RECEPTACLE WITH
 SWING-OUT DOOR.

DATE 06-10-19

DWG. NO. AI-3006