

WHOLESALE PRICE LIST

F040124-270-A

EFFECTIVE April 1, 2024

Rev.: 3-12-26

ORDERS TOLL FREE: 800-762-5002



RJ Thomas Mfg. Co., Inc.

Mailing: PO Box 946, Cherokee, IA 51012-0946
Physical: 5648 Hwy 59 South, Cherokee, IA 51012
Phone: 712-225-5115 • 800-762-5002
Fax: 712-225-5796
E-mail: pilotrock@rjthomas.com
Web Site: www.pilotrock.com

TABLE of CONTENTS

Catalog #270 Page	Price List Page	Catalog #270 Page	Price List Page
4-27	PARK & STREET BENCHES	1-13	
4	Square Frame Bench -B130 Series	1	
5	Recycled Plastic Bench -RBF & RBB Series	1	
6-7	Channel Bench -CXB Series	1-2	
8	Contemporary Steel Bench -B120 Series	3	
9	Accessible Bench -B110 & B111 Series	3	
9	Classic Bench -CLB Series	3	
10	Contour Bench -WRB & OWRB Series	3-4	
11	Trailside Bench -WB & OWB Series	4	
12	Amherst Bench -B100 & B102 Series	4	
13	Wall Mount Bench -WMB Series	4-5	
13	Park Avenue Bench -BC3000 & BC4000 Series	5	
14	Grey Creek Bench -B30 Series	5	
15	Silver Sioux Bench -B40 Series	6	
16-17	Riverview Bench -B60 & B70 Series	6-7	
18	Gillette Bench -B80 Series	7	
19	Oak Knoll Bench -B90 Series	7	
20-21	Athletic Benches -B300, AB, & APB Series	8-10	
22-23	Sign Benches -B400 & B410 Series	11	
	Bench Frames Only, <i>New!</i> Bench Foot Pads	12	
24-25	Signage & Accessories	13	
26	Armrests for Benches, Cover Caps	13	
28-51	PARK TABLES	14-33	
28	Heavy Duty Table -UT Series	14	
29	Extra Heavy Duty Table -XT Series	14-15	
30	Accessible Tables -UT, XT, UTH, XTH Series	15-17	
31	Kid's Tables -UTK, SQT, T104K Series	17-18	
32	Universal Access Tables -WXT & WXTH Series	18-19	
33	Universal Access Table -WPTS Series	19	
33	<i>New!</i> Custom Identity Table -T720 Series	19-20	
34-35	A-Frame Tables -AFT, AT, WAT Series	20	
36	Caterpillar Table -T600 Series	20-21	
36	Light Duty Table -BT Series	21	
37	Recycled Plastic Tables -RT & ART Series	21	
38	Square Table -Portable -SQT Series	22	
39	Square Table -Pedestal -PQT Series	22-23	
40-41	Round Tables -T100, T200, T300, T400 Series	24	
42	Multi-Pedestal Table -APT Series	25-26	
43	Twin Pedestal Table -TPT Series	26-27	
43	Single Pedestal Table -PT Series	28	
44	Square Frame Table & Utility Table -T700 Series	28	
45	Food Court Table -FCT Series	28	
46	Snow Load & Extreme Load Rated Tables	29	
	Table Frames Only	29-31	
48	Accessories for Tables -Umbrellas	32	
49-50	Accessories for Tables - <i>New!</i> Umbrella Base	33	
58-77	WASTE & RECYCLING	34-41	
58	Bear Resistant Trash Receptacle -BPRT Series	34	
59	Varmint Defiant Trash Can Cover -VDT Series	34	
59	Park Policeman -CN-EXP Series	34	
60	Round Receptacle -Vertical Steel Strap -CN-R/SS2 Series	34	
60	Round Receptacle -Perforated Steel -CN-R/R Series	34	
61	Round Receptacle -Expanded Steel -CN-R/D Series	34	
61	Round Receptacle -Cut Steel Plate -CN-R/SP2 Series	35	
62	Round Receptacle, Lockable Door -Cut Steel -CN-R/SP3-36D	35	
62	Round Receptacle with Door -Steel Strap -CN-R/SS2-36D	35	
63	Amherst Receptacle -Round & Square -AMR & AMQ Series	35	
63	Round Receptacle -Vertical Wave Steel Strap -CN-R/SS3 Series	35	
64	Trash & Recycling Receptacles -Lumber & Recycled Plastic -TRH Series	35	
65	Tilting Trash Receptacle -CN-TR-52 Series	35	
65	Kolorcans Plastic Trash Receptacles	35	
66	Square Receptacle Holder -Lumber & Recycled Plastic -TRQ Series	36	
66	Square Receptacle -Expanded Steel -CN-Q/D-32 Series	36	
67	Square Frame Receptacle -CN-Q-36 Series	36	
67	Square Receptacle with Door -Steel Strap -CN-Q/SS4-36D	36	
68-71	Trash & Recycling Receptacle Lids	36-38	
72	Trash & Recycling Receptacle & Lid Accessories	38	
73	Trash Cans and Liners	39	
74	Stationary Mounts for Trash Receptacles	39	
continued	WASTE & RECYCLING	continued	
74	Smoker's Stack	40	
75	Trash Can Hangers	40	
76	Recycling Arrays -RA Series	40	
77	Pet Waste Collection Stations -Pilot Rock & Dogipot	41	
78-79	DOG PARK PRODUCTS	41	
78	Playgrounds for Dogs	41	
79	Products for People	41	
80-87	SITE AMENITIES	42-46	
80-81	Bear Resistant Food Lockers -BPFL Series & <i>New!</i> BPFL-ADA	42	
82	Lantern Poles	42	
83	Traffic Barriers	42	
84-85	Utility Tables	43-44	
86	Condiment Serving Table -CST Series	45	
86	<i>New!</i> Marksman Shooting Table -MST-1 Series	45	
87	Planters, Toilet Tissue Dispensers	45	
	<i>New!</i> U.S. Flag Retirement Drop Box	46	
88-89	WAYFINDING SIGNS	46	
90-95	BIKE RACKS	47-48	
90	Safety Bike Rack	47	
90	Omega Bike Rack	47	
91	Bollard Bike Rack	47	
91	Hoop Bike Rack	47	
92	Vertical Bike Rack	47	
93	"Wheel" Style Vertical Bike Rack	47	
93	Steel Wheels Bike Rack	47	
94	Hitching Post Bike Rack	48	
94	Hitching Post Group Bike Rack	48	
95	Saddleback Bike Rack	48	
96-111	PARK GRILLS	49-51	
96-97	Accessible Grill -ASW & ASWS Series	49	
98-99	Premier Series Grills -A, B, C, & D Series	49	
100-104	Multilevel Grills -N, Q, H, J, & K Series	49-50	
105	Covered Grills -EC Series	51	
106-107	Large Group Grills -Q3, P, & L Series	51	
108	Grill Station -GS Series	51	
109	Hot Coal Bin - <i>New!</i> Hot Coal Bin Covers	51	
110	Grill Options and Accessories	49-51	
112-125	CAMPFIRE RINGS	52-55	
112	Campfire Rings -FX Series -No Grate	52	
113	Campfire Rings -FA Series -Infinitely Adjustable Grate	52	
114	Campfire Rings -FS Series -Single Level Grate	52-53	
115	Campfire Rings -FSW Series -Single Level Swivel Grate	53	
116	Multilevel Campfire Ring -L Series	53	
116	Large Group Campfire Firering -O Series	53	
117	Snow Load Rated Swivel Grate Firerings -FSW/SL Series	54	
118-119	Accessible Firerings -M, LDW, FS, FSW, FSDW Series	54	
120	Stainless Steel Campfire Rings -FSWS & FXS Series	54	
120	Removable Cooking Grate -Model I-RS	55	
121	<i>New!</i> Firering Spark Arrestor -FRSA Series	55	
122	Drop-in Cooking Grate for Firerings -Model DIG-U4	55	
122	<i>New!</i> Foldable Cooking Grate -Model DIG-R35	55	
123	Campfire Ring Covers -CF Series	55	
123	<i>New!</i> Firering Lockout Cover -Model FLC/B-30 & FLC/B-26	55	
124	Firering Clean Out Shovel -Model FCS-1	55	
124	Utility Shelf	55	
124	Heat Shields	55	
126-127	Anchor Kits - <i>New!</i> ANG-6 Square Tube Strap Anchor	56-57	
52-57	Finish, Material, & Color Options	57-59	
128	Ordering & Shipping Information	60	
129	Product Warranty	61	
129	California Proposition 65 Warnings	61	

Please make out Purchase Orders and Payments to:
RJ Thomas Mfg. Co., Inc.
Most products available on GSA Contracts
OFFICE HOURS:
8:00 am to 5:00 pm Central Time: Monday - Friday
Closed weekends and holidays

BENCHES

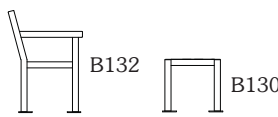
		<p>SQUARE FRAME BENCH - B130 Series (Catalog Page 4)</p> <p>B130 Series Flat Bench or B132 Series Contour Bench, surface mount only (anchors not included). Square end frame design of 2" x 2" x 11 ga. square steel tube, 1" x 2" x 14 ga. rectangular steel tube seat and backrest framework with formed steel channel reinforcements. *Powder coated paint finish. Factory inlaid 2" x 4" nom. seat slats and 1" x 4" nom. backrest slats of Recycled Plastic.</p>							
<p>B130 Series Flat Bench - Powder Coated Frames, Black standard */(CB) Surface Mount</p>				<p>B132 Series Contour Bench - Powder Coated Frames, Black standard */(CB) Surface Mount</p>					
Model No.	Length (ft.)	Material	Wt. (lbs.)	Price	Model No.	Length (ft.)	Material	Wt. (lbs.)	Price
B130/CB-4PC	4	*Cedar colored Recycled Plastic	79	\$448.00	B132/CB-4PC	4	*Cedar colored Recycled Plastic	148	\$1,005.00
B130/CB-6PC	6		104	\$518.00	B132/CB-6PC	6		204	\$1,223.00
B130/CB-8PC	8		130	\$597.00	B132/CB-8PC	8		251	\$1,410.00

		<p>100% RECYCLED PLASTIC BENCH - RBF & RBB Series (Catalog Page 5)</p> <p>Flat (RBF Series) or Contour (RBB Series) Bench frames of 3" thick, single piece, solid molded 100% recycled plastic. Solid color throughout, UV stabilizer added for ultraviolet protection. Portable/surface mount, Stainless Steel screws for assembly included. Standard frame colors: Black, Brown, or Green - other colors available as special order.</p>							
<p>Flat - Brown Recycled Plastic Frames standard */(W)</p>				<p>Contour - Brown Recycled Plastic Frames standard */(W)</p>					
Model No.	Length (ft.)	Material	Wt. (lbs.)	Price	Model No.	Length (ft.)	Material	Wt. (lbs.)	Price
RBF/W-4C24	4	(5) 2" x 4" *Cedar colored Slats	74	\$545.00	RBB/W-4C24	4	(6) 2" x 4" *Cedar colored Slats	96	\$667.00
RBF/W-6C24	6		111	\$817.00	RBB/W-6C24	6		143	\$998.00
RBF/W-4C26	4	(3) 2" x 6" *Cedar colored Slats	72	\$545.00	RBB/W-4C26	4	(4) 2" x 6" *Cedar colored Slats	98	\$667.00
RBF/W-6C26	6		107	\$817.00	RBB/W-6C26	6		147	\$998.00
RBF/W-4C21	4	(2) 2" x 10" *Cedar colored Planks	71	\$545.00	RBB/W-4C21	4	(2) 2" x 10" *Cedar colored Planks	83	\$667.00
RBF/W-6C21	6		107	\$817.00	RBB/W-6C21	6		125	\$998.00

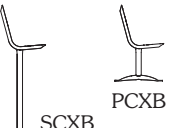
<p>CHANNEL BENCH - CXB Series (Catalog Pages 6 & 7)</p> <p>Contour Bench, 2-3/8" O.D. steel pipe frame post and portable foot (PCXB), 1/8" thick (11 ga.) die-formed seat and back channel.</p> <p>SCXB: embedded installation PCXB: portable/surface mount</p> 	<p>Powder Coated Frames, Black standard */(CB) Model No.</p>		<p>Hot-Dip Galvanized Frames (/G) Model No.</p>		<p>Length (ft.)</p>	<p>Material</p>	<p>Wt. (lbs.)</p>	<p>Price</p>
	SCXB/CB-4TP24	SCXB/G-4TP24	4	<p>(6) 2" x 4" *Treated #1 Southern Yellow Pine Slats</p>				
	SCXB/CB-6TP24	SCXB/G-6TP24	6		75	\$356.00		
	SCXB/CB-8TP24	SCXB/G-8TP24	8		90	\$389.00		
	SCXB3/CB-15TP24	SCXB3/G-15TP24	15, 3 Frames		161	\$630.00		
	PCXB/CB-4TP24	PCXB/G-4TP24	4		66	\$320.00		
	PCXB/CB-6TP24	PCXB/G-6TP24	6		81	\$356.00		
	PCXB/CB-8TP24	PCXB/G-8TP24	8		98	\$389.00		
	PCXB3/CB-15TP24	PCXB3/G-15TP24	15, 3 Frames		170	\$630.00		
	SCXB/CB-4AL	SCXB/G-4AL	4		<p>(2) 2" x 10" *Clear Anodized Aluminum Planks</p>	44	\$455.00	
	SCXB/CB-6AL	SCXB/G-6AL	6			51	\$558.00	
	SCXB/CB-8AL	SCXB/G-8AL	8	58		\$661.00		
	SCXB3/CB-15AL	SCXB3/G-15AL	15, 3 Frames	99		\$1,145.00		
	SCXB5/CB-21AL	SCXB5/G-21AL	21, 5 Frames	150		\$1,525.00		
	SCXB5/CB-24AL	SCXB5/G-24AL	24, 5 Frames	160		\$1,680.00		
	PCXB/CB-4AL	PCXB/G-4AL	4	50		\$455.00		
	PCXB/CB-6AL	PCXB/G-6AL	6	57		\$558.00		
	PCXB/CB-8AL	PCXB/G-8AL	8	66		\$661.00		
	PCXB3/CB-15AL	PCXB3/G-15AL	15, 3 Frames	108		\$1,145.00		
	PCXB5/CB-21AL	PCXB5/G-21AL	21, 5 Frames	169	\$1,525.00			
	PCXB5/CB-24AL	PCXB5/G-24AL	24, 5 Frames	179	\$1,680.00			
	SCXB/CB-4AR	SCXB/G-4AR	4	<p>(2) 2" x 10" *Red Powder Coated Aluminum Planks</p>	44	\$455.00		
	SCXB/CB-6AR	SCXB/G-6AR	6		51	\$558.00		
	SCXB/CB-8AR	SCXB/G-8AR	8		58	\$661.00		
	PCXB/CB-4AR	PCXB/G-4AR	4		50	\$455.00		
	PCXB/CB-6AR	PCXB/G-6AR	6		57	\$558.00		
	PCXB/CB-8AR	PCXB/G-8AR	8		66	\$661.00		
	SCXB/CB-4PC24	SCXB/G-4PC24	4	<p>(6) 2" x 4" *Cedar colored Recycled Plastic Slats</p>	85	\$485.00		
	SCXB3/CB-6PC24	SCXB3/G-6PC24	6, 3 Frames		127	\$724.00		
	PCXB/CB-4PC24	PCXB/G-4PC24	4		91	\$485.00		
PCXB3/CB-6PC24	PCXB3/G-6PC24	6, 3 Frames	136		\$724.00			

CHANNEL BENCH - CXB Series ... continued on Page 2

*See Pages 57 - 59 for optional lumber species, material color options, and the character designators to specify those options in the Model Numbers.

RJ Thomas Mfg. Co., Inc.

P.O. Box 946 • Cherokee, Iowa 51012-0946 • ORDERS Toll Free: 800-762-5002 • FAX: 712-225-5796 • 712-225-5115

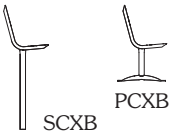
CHANNEL BENCH - CXB Series (Catalog Pages 6 & 7) ... continued Contour Bench, 2-3/8" O.D. steel pipe frame post and portable foot (PCXB), 1/8" thick (11 ga.) die-formed seat and back channel. SCXB: embedded installation PCXB: portable/surface mount	Powder Coated Frames, Black standard * (/CB) Model No.	Hot-Dip Galvanized Frames (/G) Model No.	Length (ft.)	Material	Wt. (lbs.)	Price
		SCXB/CB-4VW10	SCXB/G-4VW10	4	(2) 2" x 10" *Brown Thermo-plastic Coated Expanded Steel Planks	65
SCXB/CB-6VW10		SCXB/G-6VW10	6	89		\$704.00
SCXB/CB-8VW10		SCXB/G-8VW10	8	103		\$779.00
SCXB3/CB-10VW10		SCXB3/G-10VW10	10, 3 Frames	138		\$1,085.00
SCXB4/CB-16VW10		SCXB4/G-16VW10	16, 4 Frames	206		\$1,558.00
PCXB/CB-4VW10		PCXB/G-4VW10	4	71		\$554.00
PCXB/CB-6VW10		PCXB/G-6VW10	6	97		\$704.00
PCXB/CB-8VW10		PCXB/G-8VW10	8	113		\$779.00
PCXB3/CB-10VW10		PCXB3/G-10VW10	10, 3 Frames	150		\$1,085.00
PCXB4/CB-16VW10		PCXB4/G-16VW10	16, 4 Frames	226		\$1,558.00
SCXB/CB-4VW12		SCXB/G-4VW12	4	73		\$683.00
SCXB/CB-6VW12		SCXB/G-6VW12	6	97		\$761.00
SCXB/CB-8VW12		SCXB/G-8VW12	8	111	\$818.00	
SCXB3/CB-10VW12		SCXB3/G-10VW12	10, 3 Frames	150	\$1,121.00	
SCXB4/CB-16VW12		SCXB4/G-16VW12	16, 4 Frames	222	\$1,636.00	
PCXB/CB-4VW12		PCXB/G-4VW12	4	79	\$683.00	
PCXB/CB-6VW12		PCXB/G-6VW12	6	105	\$761.00	
PCXB/CB-8VW12		PCXB/G-8VW12	8	121	\$818.00	
PCXB3/CB-10VW12		PCXB3/G-10VW12	10, 3 Frames	162	\$1,121.00	
PCXB4/CB-16VW12		PCXB4/G-16VW12	16, 4 Frames	242	\$1,636.00	
SCXB/CB-4HW10		SCXB/G-4HW10	4	(2) 2" x 10" *Brown Thermo-plastic Coated Perforated Steel Planks	69	\$564.00
SCXB/CB-6HW10		SCXB/G-6HW10	6		93	\$725.00
SCXB/CB-8HW10		SCXB/G-8HW10	8		111	\$839.00
SCXB3/CB-10HW10		SCXB3/G-10HW10	10, 3 Frames		146	\$1,165.00
SCXB4/CB-16HW10	SCXB4/G-16HW10	16, 4 Frames	222		\$1,678.00	
PCXB/CB-4HW10	PCXB/G-4HW10	4	75		\$564.00	
PCXB/CB-6HW10	PCXB/G-6HW10	6	101		\$725.00	
PCXB/CB-8HW10	PCXB/G-8HW10	8	121		\$839.00	
PCXB3/CB-10HW10	PCXB3/G-10HW10	10, 3 Frames	158		\$1,165.00	
PCXB4/CB-16HW10	PCXB4/G-16HW10	16, 4 Frames	242		\$1,678.00	
SCXB/CB-4HW12	SCXB/G-4HW12	4	(2) 2" x 12" *Brown Thermo-plastic Coated Perforated Steel Planks		81	\$691.00
SCXB/CB-6HW12	SCXB/G-6HW12	6			99	\$787.00
SCXB/CB-8HW12	SCXB/G-8HW12	8		119	\$900.00	
SCXB3/CB-10HW12	SCXB3/G-10HW12	10, 3 Frames		162	\$1,206.00	
SCXB4/CB-16HW12	SCXB4/G-16HW12	16, 4 Frames		238	\$1,800.00	
PCXB/CB-4HW12	PCXB/G-4HW12	4		87	\$691.00	
PCXB/CB-6HW12	PCXB/G-6HW12	6		107	\$787.00	
PCXB/CB-8HW12	PCXB/G-8HW12	8		129	\$900.00	
PCXB3/CB-10HW12	PCXB3/G-10HW12	10, 3 Frames		174	\$1,206.00	
PCXB4/CB-16HW12	PCXB4/G-16HW12	16, 4 Frames		258	\$1,800.00	
SCXB/CB-6SC/TW	SCXB/G-6SC/TW	6		(2) 2" x 11" *Brown Thermo-plastic Coated Formed Steel Channel Planks	115	\$787.00
SCXB/CB-8SC/TW	SCXB/G-8SC/TW	8			135	\$900.00
PCXB/CB-6SC/TW	PCXB/G-6SC/TW	6	121		\$787.00	
PCXB/CB-8SC/TW	PCXB/G-8SC/TW	8	143		\$900.00	

CHANNEL BENCH - CXB Series ... continued on Page 3

*See Pages 57 - 59 for optional lumber species, material color options, and the character designators to specify those options in the Model Numbers.

RJ Thomas Mfg. Co., Inc.

P.O. Box 946 • Cherokee, Iowa 51012-0946 • ORDERS Toll Free: 800-762-5002 • FAX: 712-225-5796 • 712-225-5115

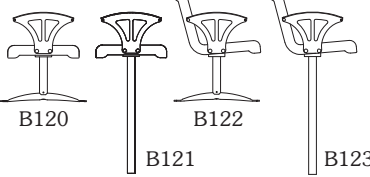
CONTEMPORARY STEEL BENCH - B120 Series (Catalog Page 8)						Replace ♦ in Model No. with DW for Expanded Steel, RW for Perforated Steel, SP/TW for Cut Steel Plate (all 3 *Brown Thermo-plastic Coated finish), or SS/CB for Steel Strap (*Black Powder Coated finish).			
Flat or Contour Benches, embedded or surface mount. All-welded, 2-3/8" O.D. steel pipe frame post and surface mount foot. 7 ga. steel armrests.		*Brown Thermo-plastic Coated Expanded Steel ♦ = (DW)		*Brown Thermo-plastic Coated Perforated Steel ♦ = (RW)		*Brown Thermo-plastic Coated Cut Steel Plate ♦ = (SP/TW)		*Black Powder Coated Steel Strap ♦ = (SS/CB)	
Model No.	Length (ft.)	Frame Configuration		Wt. (lbs.)	Price	Wt. (lbs.)	Price	Wt. (lbs.)	Price
B120 Series Flat Bench - Powder Coated Frames, Black standard */(CB) Surface Mount									
B120/CB-4♦	4	2 End Frames		86	\$815.00	91	\$864.00	88	\$864.00
B120/CB-6♦	6	2 End Frames		109	\$927.00	115	\$988.00	114	\$988.00
B120/CB-8♦	8	2 End Frames		133	\$1,113.00	141	\$1,113.00	141	\$1,113.00
B121 Series Flat Bench - Powder Coated Frames, Black standard */(CB) Embedded Mount									
B121/CB-4♦	4	2 End Frames		86	\$815.00	91	\$864.00	88	\$864.00
B121/CB-6♦	6	2 End Frames		109	\$927.00	115	\$988.00	114	\$988.00
B121/CB-8♦	8	2 End Frames		133	\$1,113.00	141	\$1,113.00	141	\$1,113.00
B122 Series Contour Bench - Powder Coated Frames, Black standard */(CB) Surface Mount									
B122/CB-4♦	4	2 End Frames		106	\$972.00	113	\$1,037.00	117	\$1,037.00
B122/CB-6♦	6	2 End Frames		130	\$1,134.00	139	\$1,215.00	150	\$1,215.00
B122/CB-8♦	8	2 End Frames		161	\$1,294.00	172	\$1,394.00	187	\$1,394.00
B123 Series Contour Bench - Powder Coated Frames, Black standard */(CB) Embedded Mount									
B123/CB-4♦	4	2 End Frames		106	\$972.00	113	\$1,037.00	117	\$1,037.00
B123/CB-6♦	6	2 End Frames		130	\$1,134.00	139	\$1,215.00	150	\$1,215.00
B123/CB-8♦	8	2 End Frames		161	\$1,294.00	172	\$1,394.00	187	\$1,394.00

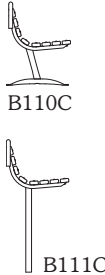
	ACCESSIBLE BENCH - B110 Series (Catalog Page 9)	Powder Coated Frames, Black standard */(CB) Model No.	Hot-Dip Galvanized Frames (/G) Model No.	Length (ft.)	Material	Wt. (lbs.)	Price
		Contour Bench, 2-3/8" O.D. steel pipe frame post and foot (B110), 1/8" thick (11 ga.) die-formed seat and back channel. Accessible full-length grab bar. B110C: surface mount B111C: embedded installation	B110C/CB-6TP24				
B111C/CB-6TP24	B111C/G-6TP24	6, 3 Frames	127	\$511.00			
	B110C/CB-6PC24	B110C/G-6PC24	6, 3 Frames	(8) 2" x 4" *Cedar colored Recycled Plastic Slats	176	\$805.00	
	B111C/CB-6PC24	B111C/G-6PC24	6, 3 Frames		176	\$805.00	

CLASSIC BENCH - CLB Series (Catalog Page 9)									
One-piece, die-formed, structural steel channel frames, portable/surface mount. Diagonal and horizontal braces.									
Hot-Dip Galvanized Frames (/G)									
Model No.	Length (ft.)	Material	Wt. (lbs.)	Price	Model No.	Length (ft.)	Material	Wt. (lbs.)	Price
CLB/G-4HW	4	(7) 3/4" x 3" Hardwood Slats	49	\$261.00	CLB/G-4PC13	4	(7) 1" x 3" *Cedar colored Recycled Plastic Slats	60	\$419.00
CLB/G-6HW	6		68	\$326.00	CLB3/G-6PC13	6, 3 Frames		87	\$571.00

CONTOUR BENCH - WRB Series (Catalog Page 10)	Powder Coated Frames, Black standard */(CB) Model No.	Hot-Dip Galvanized Frames (/G) Model No.	Length (ft.)	Material	Wt. (lbs.)	Price
	Contour Bench, 2-1/2" sq. steel tube posts, 3/8" thick steel seat bracket and portable frame foot (PWRB). SWRB: embedded installation PWRB: portable/surface mount	SWRB/CB-4CO34				
	SWRB/CB-6CO34	SWRB/G-6CO34	6	118	\$1,161.00	
	SWRB/CB-8CO34	SWRB/G-8CO34	8	140	\$1,161.00	
	PWRB/CB-4CO34	PWRB/G-4CO34	4	101	\$826.00	
	PWRB/CB-6CO34	PWRB/G-6CO34	6	124	\$1,161.00	
	PWRB/CB-8CO34	PWRB/G-8CO34	8	146	\$1,161.00	
	SWRB/CB-4PC34	SWRB/G-4PC34	4	(8) 3" x 4" *Cedar colored Recycled Plastic Timbers	150	\$892.00
	SWRB3/CB-6PC34	SWRB3/G-6PC34	6, 3 Frames		224	\$1,336.00
	SWRB3/CB-8PC34	SWRB3/G-8PC34	8, 3 Frames		274	\$1,586.00
	PWRB/CB-4PC34	PWRB/G-4PC34	4		156	\$892.00
	PWRB3/CB-6PC34	PWRB3/G-6PC34	6, 3 Frames		233	\$1,336.00
	PWRB3/CB-8PC34	PWRB3/G-8PC34	8, 3 Frames		283	\$1,586.00

CONTOUR BENCH - WRB Series ... continued on Page 4

*See Pages 57 - 59 for optional lumber species, material color options, and the character designators to specify those options in the Model Numbers.

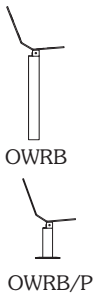

CONTOUR BENCH - OWRB Series (Catalog Page 10) ... continued	Powder Coated Frames, Black standard */(CB) Model No.	Hot-Dip Galvanized Frames (/G) Model No.	Length (ft.)	Material	Wt. (lbs.)	Price
	Contour Bench, 4" sq. steel tube post, 2-1/2" sq. steel tube horizontal seat support, 3/8" thick steel seat brackets. OWRB: embedded installation OWRB/P: base plate surface mount	OWRB/CB-4CO34	OWRB/G-4CO34	4	(8) 3" x 4"	106
OWRB/CB-6CO34		OWRB/G-6CO34	6	133		\$1,067.00
OWRB/P/CB-4CO34		OWRB/P/G-4CO34	4	106		\$896.00
OWRB/P/CB-6CO34		OWRB/P/G-6CO34	6	*Construction Heart Redwood Timbers	133	\$1,067.00
OWRB/CB-4PC34		OWRB/G-4PC34	4		161	\$964.00
OWRB3/CB-6PC34		OWRB3/G-6PC34	6, 3 Supports		229	\$1,241.00
OWRB/P/CB-4PC34		OWRB/P/G-4PC34	4	*Cedar colored Recycled Plastic Timbers	161	\$964.00
OWRB3/P/CB-6PC3		OWRB3/P/G-6PC34	6, 3 Supports		229	\$1,241.00

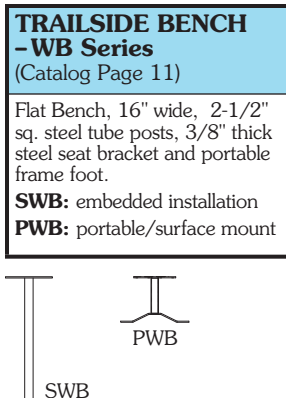

TRAILSIDE BENCH - WB Series (Catalog Page 11)	Powder Coated Frames, Black standard */(CB) Model No.	Hot-Dip Galvanized Frames (/G) Model No.	Length (ft.)	Material	Wt. (lbs.)	Price
	Flat Bench, 16" wide, 2-1/2" sq. steel tube posts, 3/8" thick steel seat bracket and portable frame foot. SWB: embedded installation PWB: portable/surface mount	SWB/CB-4CO34	SWB/G-4CO34	4	(4) 3" x 4"	57
SWB/CB-6CO34		SWB/G-6CO34	6	68		\$590.00
SWB/CB-8CO34		SWB/G-8CO34	8	79		\$590.00
PWB/CB-4CO34		PWB/G-4CO34	4	61		\$519.00
PWB/CB-6CO34		PWB/G-6CO34	6	72		\$590.00
PWB/CB-8CO34		PWB/G-8CO34	8	83		\$590.00
SWB/CB-4PC34		SWB/G-4PC34	4	*Construction Heart Redwood Timbers	84	\$553.00
SWB3/CB-6PC34		SWB3/G-6PC34	6, 3 Frames		126	\$830.00
SWB3/CB-8PC34		SWB3/G-8PC34	8, 3 Frames		151	\$952.00
PWB/CB-4PC34		PWB/G-4PC34	4		88	\$553.00
PWB3/CB-6PC34		PWB3/G-6PC34	6, 3 Frames		132	\$830.00
PWB3/CB-8PC34		PWB3/G-8PC34	8, 3 Frames		157	\$952.00

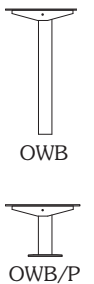

TRAILSIDE BENCH - OWB Series (Catalog Page 11)	Powder Coated Frames, Black standard */(CB) Model No.	Hot-Dip Galvanized Frames (/G) Model No.	Length (ft.)	Material	Wt. (lbs.)	Price
	Flat Bench, 24" wide, 4" sq. steel tube post, 2-1/2" sq. steel tube horizontal seat support, 3/8" thick steel seat brackets. OWB: embedded installation OWB/P: base plate surface mount	OWB/CB-4CO34	OWB/G-4CO34	4	(6) 3" x 4"	88
OWB/CB-6CO34		OWB/G-6CO34	6	109		\$858.00
OWB/P/CB-4CO34		OWB/P/G-4CO34	4	88		\$706.00
OWB/P/CB-6CO34		OWB/P/G-6CO34	6	*Construction Heart Redwood Timbers	109	\$858.00
OWB/CB-4PC34		OWB/G-4PC34	4		129	\$793.00
OWB3/CB-6PC34		OWB3/G-6PC34	6, 3 Supports		175	\$1,006.00
OWB/P/CB-4PC34		OWB/P/G-4PC34	4	*Cedar colored Recycled Plastic Timbers	129	\$793.00
OWB3/P/CB-6PC34		OWB3/P/G-6PC34	6, 3 Supports		175	\$1,006.00

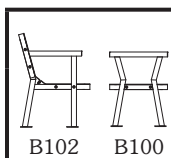

AMHERST BENCH - B100 Series (Catalog Page 12)	
Flat (B100 Series) or Contour (B102 Series) all steel, bolt-together Bench, portable/surface mount. 3/16" thick (7 ga.) steel seat and back sections, 2" sq. x 10 ga. wall steel tube frames.	
Powder Coated finish - Black standard */(CB)	
Model No.	Length (ft.)
B100/CB-6	6
B102/CB-6	6

† For alternate designs specify Design 2, Design 3, Design 4, Design 5, or Design 6.

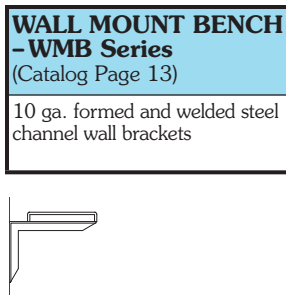
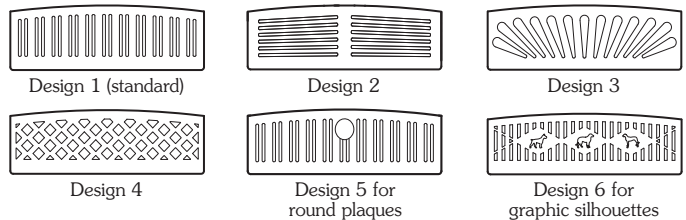

WALL MOUNT BENCH - WMB Series (Catalog Page 13)	Powder Coated Frames, Black standard */(CB) Model No.	Hot-Dip Galvanized Frames (/G) Model No.	Length (ft.)	Material	Wt. (lbs.)	Price
	10 ga. formed and welded steel channel wall brackets	WMB/CB-4TP24	WMB/G-4TP24	4	(3) 2" x 4" *Treated #1 Southern Yellow Pine Slats	32
WMB3/CB-6TP24		WMB3/G-6TP24	6, 3 Brackets	48		\$168.00
WMB3/CB-8TP24		WMB3/G-8TP24	8, 3 Brackets	60		\$190.00
WMB/CB-4AL		WMB/G-4AL	4	(1) 2" x 10" *Clear Anodized Aluminum Plank	16	\$189.00
WMB3/CB-6AL		WMB3/G-6AL	6, 3 Brackets		24	\$282.00
WMB3/CB-8AL		WMB3/G-8AL	8, 3 Brackets		28	\$334.00
WMB/CB-4AR		WMB/G-4AR	4	(1) 2" x 10" *Red Powder Coated Aluminum Plank	16	\$189.00
WMB3/CB-6AR		WMB3/G-6AR	6, 3 Brackets		24	\$282.00
WMB3/CB-8AR		WMB3/G-8AR	8, 3 Brackets		28	\$334.00

WALL MOUNT BENCH - WMB Series ... continued on Page 5

*See Pages 57 - 59 for optional lumber species, material color options, and the character designators to specify those options in the Model Numbers.

RJ Thomas Mfg. Co., Inc.





P.O. Box 946 • Cherokee, Iowa 51012-0946 • ORDERS Toll Free: 800-762-5002 • FAX: 712-225-5796 • 712-225-5115

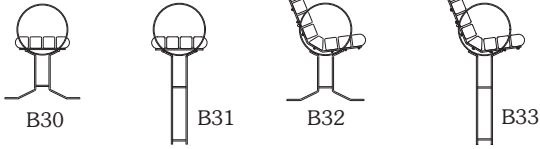

WALL MOUNT BENCH - WMB Series (Catalog Page 13) ... continued		Powder Coated Frames, Black standard */(CB) Model No.	Hot-Dip Galvanized Frames (/G) Model No.	Length (ft.)	Material	Wt. (lbs.)	Price
	10 ga. formed steel channel wall brackets	WMB/CB-4PC24	WMB/G-4PC24	4	(3) 2" x 4"	36	\$195.00
		WMB3/CB-6PC24	WMB3/G-6PC24	6, 3 Brackets	*Cedar colored	54	\$301.00
		WMB4/CB-8PC24	WMB4/G-8PC24	8, 4 Brackets	Recycled Plastic Slats	72	\$396.00
		WMB/CB-4VW12	WMB/G-4VW12	4	(1) 2-1/2" x 12" *Brown	30	\$289.00
		WMB3/CB-6VW12	WMB3/G-6VW12	6, 3 Brackets	Thermo-plastic Coated	52	\$368.00
		WMB3/CB-8VW12	WMB3/G-8VW12	8, 3 Brackets	Expanded Steel Plank	69	\$406.00
		WMB/CB-4HW12	WMB/G-4HW12	4	(1) 2-1/2" x 12" *Brown	34	\$293.00
		WMB3/CB-6HW12	WMB3/G-6HW12	6, 3 Brackets	Thermo-plastic Coated	53	\$384.00
		WMB3/CB-8HW12	WMB3/G-8HW12	8, 3 Brackets	Perforated Steel Plank	70	\$442.00
		WMB3/CB-6SC/TW	WMB3/G-6SC/TW	6, 3 Brackets	(1) 2" x 11" *Brown Thermo-plastic	42	\$417.00
		WMB3/CB-8SC/TW	WMB3/G-8SC/TW	8, 3 Brackets	Coated Formed Steel Channel Plank	51	\$476.00

PARK AVENUE BENCH - BC3000 & BC4000 Series (Catalog Page 13)										
Flat (BC3000 Series) or Contour (BC4000 Series) Bench, portable/surface mount. Cast aluminum frames finished in choice of 3 polyester powder coat colors .										
Powder Coated Frames - Black standard ‡/(CB)										
Model No.		Length (ft.)	Material	Wt. (lbs.)	Price	Model No.	Length (ft.)	Material	Wt. (lbs.)	Price
BC3004/CB-4PC		4	(4) 2" x 4"	54	\$970.00	BC4004/CB-4PC	4	(8) 2" x 4"	108	\$1,406.00
BC3000/CB-5PC		5	*Cedar colored	72	\$1,122.00	BC4000/CB-5PC	5	*Cedar colored	124	\$1,563.00
BC3001/CB-6PC		6	Recycled Plastic	80	\$1,266.00	BC4001/CB-6PC	6	Recycled Plastic	140	\$1,660.00
BC3002/CB-8PC		8, 3 Frames	Slats	97	\$1,690.00	BC4002/CB-8PC	8, 3 Frames	Slats	188	\$1,953.00
‡ Replace /CB in Model No. with /CN for Hunter Green Powder Coated finish or /CW for Brown.										

GREY CREEK BENCH - B30 Series (Catalog Page 14)							Replace ♦ in Model No. with CO for Construction Heart Redwood or PC for *Cedar colored Recycled Plastic.							
Flat or Contour Benches, embedded or portable/surface mount. All-welded, flat steel plate frames with wide-surface armrests. 3" x 4" nominal sized timbers.			B30		B31		B32		B33		Construction Heart Redwood ♦ = CO		*Cedar colored Recycled Plastic ♦ = PC	
Powder Coated Frames, Black standard */(CB) Model No.	Hot-Dip Galvanized Frames (/G) Model No.	Length (ft.)	Frame Configuration				Wt. (lbs.)	Price	Wt. (lbs.)	Price	Wt. (lbs.)	Price		
B30 Series Flat Bench Surface Mount, (4) 3" x 4" nominal sized timbers														
B30/CB-4♦34	B30/G-4♦34	4	2 End Frames				103	\$530.00	136	\$663.00				
B30/CB-6♦34	B30/G-6♦34	6	2 End Frames, Lumber only				114	\$756.00	NA	NA				
B30C/CB-6♦34	B30C/G-6♦34	6	2 End Frames, 1 Center Frame, Recycled Plastic only				NA	NA	194	\$948.00				
B30C/CB-8♦34	B30C/G-8♦34	8	2 End Frames, 1 Center Frame				155	\$756.00	222	\$1,064.00				
B31 Series Flat Bench Embedded Mount, (4) 3" x 4" nominal sized timbers														
B31/CB-4♦34	B31/G-4♦34	4	2 End Frames				115	\$530.00	148	\$663.00				
B31/CB-6♦34	B31/G-6♦34	6	2 End Frames, Lumber only				126	\$756.00	NA	NA				
B31C/CB-6♦34	B31C/G-6♦34	6	2 End Frames, 1 Center Frame, Recycled Plastic only				NA	NA	212	\$948.00				
B31C/CB-8♦34	B31C/G-8♦34	8	2 End Frames, 1 Center Frame				173	\$756.00	240	\$1,064.00				
B32 Series Contour Bench Surface Mount, (8) 3" x 4" nominal sized timbers														
B32/CB-4♦34	B32/G-4♦34	4	2 End Frames				136	\$743.00	202	\$964.00				
B32/CB-6♦34	B32/G-6♦34	6	2 End Frames, Lumber only				158	\$1,042.00	NA	NA				
B32C/CB-6♦34	B32C/G-6♦34	6	2 End Frames, 1 Center Frame, Recycled Plastic only				NA	NA	292	\$1,399.00				
B32C/CB-8♦34	B32C/G-8♦34	8	2 End Frames, 1 Center Frame				214	\$1,042.00	348	\$1,632.00				
B33 Series Contour Bench Embedded Mount, (8) 3" x 4" nominal sized timbers														
B33/CB-4♦34	B33/G-4♦34	4	2 End Frames				148	\$743.00	214	\$964.00				
B33/CB-6♦34	B33/G-6♦34	6	2 End Frames, Lumber only				170	\$1,042.00	NA	NA				
B33C/CB-6♦34	B33C/G-6♦34	6	2 End Frames, 1 Center Frame, Recycled Plastic only				NA	NA	310	\$1,399.00				
B33C/CB-8♦34	B33C/G-8♦34	8	2 End Frames, 1 Center Frame				232	\$1,042.00	366	\$1,632.00				

*See Pages 57 – 59 for optional lumber species, material color options, and the character designators to specify those options in the Model Numbers.

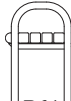
SILVER SIOUX BENCH -B40 Series (Catalog Page 15)										Replace ♦ in Model No. with CO for Construction Heart Redwood or PC for *Cedar colored Recycled Plastic.			
Flat or Contour Benches, embedded or portable/surface mount. All-welded, round steel tube frames and armrests. 3" x 4" nominal sized timbers.		B40	B41	B42	B43	Construction Heart Redwood ♦ = CO		*Cedar colored Recycled Plastic ♦ = PC					
Model No.	Length (ft.)	Frame Configuration				Wt. (lbs.)	Price	Wt. (lbs.)	Price				
B40 Series Flat Bench - Powder Coated Frames, Black standard *(/CB) Surface Mount, (4) 3" x 4" nominal sized timbers													
B40/CB-4♦34	4	2 End Frames				83	\$530.00	116	\$663.00				
B40/CB-6♦34	6	2 End Frames, Lumber only				94	\$756.00	NA	NA				
B40C/CB-6♦34	6	2 End Frames, 1 Center Frame, Recycled Plastic only				NA	NA	168	\$948.00				
B40C/CB-8♦34	8	2 End Frames, 1 Center Frame				129	\$756.00	196	\$1,064.00				
B41 Series Flat Bench - Powder Coated Frames, Black standard *(/CB) Embedded Mount, (4) 3" x 4" nominal sized timbers													
B41/CB-4♦34	4	2 End Frames				83	\$530.00	116	\$663.00				
B41/CB-6♦34	6	2 End Frames, Lumber only				94	\$756.00	NA	NA				
B41C/CB-6♦34	6	2 End Frames, 1 Center Frame, Recycled Plastic only				NA	NA	168	\$948.00				
B41C/CB-8♦34	8	2 End Frames, 1 Center Frame				129	\$756.00	196	\$1,064.00				
B42 Series Contour Bench - Powder Coated Frames, Black standard *(/CB) Surface Mount, (8) 3" x 4" nominal sized timbers													
B42/CB-4♦34	4	2 End Frames				111	\$743.00	178	\$964.00				
B42/CB-6♦34	6	2 End Frames, Lumber only				134	\$1,042.00	NA	NA				
B42C/CB-6♦34	6	2 End Frames, 1 Center Frame, Recycled Plastic only				NA	NA	260	\$1,399.00				
B42C/CB-8♦34	8	2 End Frames, 1 Center Frame				182	\$1,042.00	316	\$1,632.00				
B43 Series Contour Bench - Powder Coated Frames, Black standard *(/CB) Embedded Mount, (8) 3" x 4" nominal sized timbers													
B43/CB-4♦34	4	2 End Frames				111	\$743.00	178	\$964.00				
B43/CB-6♦34	6	2 End Frames, Lumber only				134	\$1,042.00	NA	NA				
B43C/CB-6♦34	6	2 End Frames, 1 Center Frame, Recycled Plastic only				NA	NA	260	\$1,399.00				
B43C/CB-8♦34	8	2 End Frames, 1 Center Frame				182	\$1,042.00	316	\$1,632.00				

RIVERVIEW BENCH -B60 Series (Catalog Page 16)										Replace ♦ in Model No. with CO for Construction Heart Redwood or PC for *Cedar colored Recycled Plastic.			
Flat or Contour Benches, embedded or portable/surface mount. All-welded, heavy steel pipe frames and armrests. 3" x 4" nominal sized timbers.		B60	B61	B62	B63	Construction Heart Redwood ♦ = CO		*Cedar colored Recycled Plastic ♦ = PC					
Model No.	Length (ft.)	Frame Configuration				Wt. (lbs.)	Price	Wt. (lbs.)	Price				
B60 Series Flat Bench - Powder Coated Frames, Black standard *(/CB) Surface Mount, (6) 3" x 4" nominal sized timbers													
B60/CB-4♦34	4	2 End Frames				108	\$600.00	158	\$775.00				
B60/CB-6♦34	6	2 End Frames, Lumber only				125	\$743.00	NA	NA				
B61 Series Flat Bench - Powder Coated Frames, Black standard *(/CB) Embedded Mount, (6) 3" x 4" nominal sized timbers													
B61/CB-4♦34	4	2 End Frames				116	\$600.00	170	\$775.00				
B61/CB-6♦34	6	2 End Frames, Lumber only				133	\$743.00	NA	NA				
B62 Series Contour Bench - Powder Coated Frames, Black standard *(/CB) Surface Mount, (8) 3" x 4" nominal sized timbers													
B62/CB-4♦34	4	2 End Frames				119	\$743.00	186	\$955.00				
B62/CB-6♦34	6	2 End Frames, Lumber only				142	\$886.00	NA	NA				
B63 Series Contour Bench - Powder Coated Frames, Black standard *(/CB) Embedded Mount, (8) 3" x 4" nominal sized timbers													
B63/CB-4♦34	4	2 End Frames				127	\$743.00	198	\$955.00				
B63/CB-6♦34	6	2 End Frames, Lumber only				150	\$886.00	NA	NA				

*See Pages 57 – 59 for optional lumber species, material color options, and the character designators to specify those options in the Model Numbers.

RIVERVIEW BENCH - All Steel -B70 Series (Catalog Page 17)

Flat or Contour Benches, embedded or portable/surface mount. All-welded, heavy steel pipe frames and armrests.

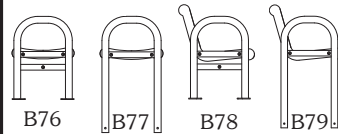

Replace ♦ in Model No. with DW for Expanded Steel, RW for Perforated Steel, SP/TW for Cut Steel Plate (all 3 *Brown Thermo-plastic Coated finish), or SS/CB for Steel Strap (*Black Powder Coated finish).

*Brown Thermo-plastic Coated Expanded Steel ♦ = DW	*Brown Thermo-plastic Coated Perforated Steel ♦ = RW	*Brown Thermo-plastic Coated Cut Steel Plate † Cut Steel Plate ♦ = SP/TW	*Black Powder Coated Steel Strap ♦ = SS/CB
---	---	--	---

Model No.	Length (ft.)	Frame Configuration	Wt. (lbs.)	Price	Wt. (lbs.)	Price	Wt. (lbs.)	Price	Wt. (lbs.)	Price
B76 Series Flat Bench - Powder Coated Frames, Black standard *(/CB) Surface Mount										
B76/CB-4♦	4	2 End Frames	107	\$890.00	112	\$945.00	109	\$945.00	143	\$945.00
B76/CB-6♦	6	2 End Frames	125	\$1,014.00	131	\$1,082.00	130	\$1,082.00	178	\$1,082.00
B76/CB-8♦	8	2 End Frames	145	\$1,139.00	153	\$1,221.00	153	\$1,221.00	214	\$1,221.00
B77 Series Flat Bench - Powder Coated Frames, Black standard *(/CB) Embedded Mount										
B77/CB-4♦	4	2 End Frames	119	\$890.00	124	\$945.00	121	\$945.00	155	\$945.00
B77/CB-6♦	6	2 End Frames	137	\$1,014.00	143	\$1,082.00	142	\$1,082.00	190	\$1,082.00
B77/CB-8♦	8	2 End Frames	157	\$1,139.00	165	\$1,221.00	165	\$1,221.00	226	\$1,221.00
B78 Series Contour Bench - Powder Coated Frames, Black standard *(/CB) Surface Mount										
B78/CB-4♦	4	2 End Frames	127	\$1,064.00	134	\$1,137.00	138	\$1,137.00	159	\$1,137.00
B78/CB-6♦	6	2 End Frames	146	\$1,242.00	155	\$1,334.00	166	\$1,334.00	205	\$1,334.00
B78/CB-8♦	8	2 End Frames	173	\$1,422.00	184	\$1,532.00	199	\$1,532.00	244	\$1,532.00
B79 Series Contour Bench - Powder Coated Frames, Black standard *(/CB) Embedded Mount										
B79/CB-4♦	4	2 End Frames	139	\$1,064.00	146	\$1,137.00	150	\$1,137.00	171	\$1,137.00
B79/CB-6♦	6	2 End Frames	158	\$1,242.00	167	\$1,334.00	178	\$1,334.00	217	\$1,334.00
B79/CB-8♦	8	2 End Frames	185	\$1,422.00	196	\$1,532.00	211	\$1,532.00	256	\$1,532.00

† For alternate Cut Steel Plate design specify Design 7 (for dog parks).

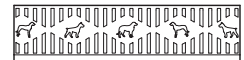

GILLETTE BENCH - B80 Series (Catalog Page 18)

Flat or Contour Benches, portable/surface mount. Cast Iron frames with powder coated paint finish. Construction Heart Redwood and Recycled Plastic are 3" x 4" nominal sized timbers.

Replace ♦ in Model No. with CO34 for Construction Heart Redwood, PC34 for *Cedar colored Recycled Plastic, SS for Steel Strap, or SP for Cut Steel Plate.

Construction Heart Redwood ♦ = CO34	*Cedar colored Recycled Plastic ♦ = PC34	*Black Powder Coated Steel Strap ♦ = SS	*Black Powder Coated Cut Steel Plate ♦ = SP
--	---	--	--

Model No.	Length (ft.)	Frame Configuration	Wt. (lbs.)	Price	Wt. (lbs.)	Price	Wt. (lbs.)	Price	Wt. (lbs.)	Price
B80 Series Flat Bench - Powder Coated Frames, Black standard *(/CB) Portable/Surface Mount										
B80/CB-4♦	4	2 End Frames	133	\$933.00	174	\$1,178.00	134	\$989.00	106	\$705.00
B80/CB-6♦	6	2 End Frames	158	\$1,084.00	220	\$1,398.00	169	\$1,198.00	121	\$777.00
B80/CB-8♦	8	2 End Frames	183	\$1,084.00	265	\$1,564.00	205	\$1,317.00	143	\$953.00
B82 Series Contour Bench - Powder Coated Frames, Black standard *(/CB) Portable/Surface Mount										
B82/CB-4♦	4	2 End Frames	169	\$1,179.00	230	\$1,540.00	150	\$1,199.00	126	\$897.00
B82/CB-6♦	6	2 End Frames	204	\$1,330.00	297	\$1,852.00	196	\$1,453.00	153	\$1,110.00
B82/CB-8♦	8	2 End Frames	239	\$1,330.00	363	\$2,157.00	235	\$1,642.00	180	\$1,326.00



OAK KNOLL BENCH - B90 Series (Catalog Page 19)

Flat or Contour Benches, portable/surface mount. Cast Iron frames for B90 Flat Benches. Cast Aluminum frames for B94 Contour Benches. Powder coated paint finish for frames. Construction Heart Redwood and Recycled Plastic are 3" x 4" nominal sized timbers.

Replace ♦ in Model No. with CO34 for construction Heart Redwood, PC34 for *Cedar colored Recycled Plastic, SS for Steel Strap, or SP for Cut Steel Plate.

Construction Heart Redwood ♦ = CO34	*Cedar colored Recycled Plastic ♦ = PC34	*Black Powder Coated Steel Strap ♦ = SS	*Black Powder Coated Cut Steel Plate ♦ = SP
--	---	--	--

Model No.	Length (ft.)	Frame Configuration	Wt. (lbs.)	Price	Wt. (lbs.)	Price	Wt. (lbs.)	Price	Wt. (lbs.)	Price
B90 Series Flat Bench - Powder Coated Cast Iron Frames, Black standard *(/CB) Portable/Surface Mount										
B90/CB-4♦	4	2 End Frames	148	\$933.00	189	\$1,109.00	149	\$913.00	121	\$705.00
B90/CB-6♦	6	2 End Frames	173	\$1,084.00	235	\$1,328.00	187	\$1,168.00	136	\$777.00
B90/CB-8♦	8	2 End Frames	198	\$1,084.00	280	\$1,625.00	223	\$1,369.00	158	\$953.00
B94 Series Contour Bench - Powder Coated Cast Aluminum Frames, Black standard *(/CB) Portable/Surface Mount										
B94/CB-4♦	4	2 End Frames	161	\$1,359.00	222	\$1,775.00	143	\$1,359.00	118	\$1,077.00
B94/CB-6♦	6	2 End Frames	196	\$1,510.00	289	\$1,960.00	211	\$1,646.00	141	\$1,290.00
B94/CB-8♦	8	2 End Frames	231	\$1,510.00	355	\$2,245.00	230	\$1,822.00	172	\$1,506.00



*See Pages 57 – 59 for optional lumber species, material color options, and the character designators to specify those options in the Model Numbers.

TEAM BENCH -B300 Series (Catalog Page 20)	Powder Coated Frames, Black standard */(CB) Model No.	Hot-Dip Galvanized Frames (/G) Model No.	Length (ft.)	Material	Wt. (lbs.)	Price
	Contour Bench with equipment deck, portable/surface mount. 2-3/8" O.D. steel pipe frame, 2-3/8" x 1-1/2" x 1/8" nom. die-formed seat, back, and deck channel.	B302/CB-6TP21	B302/G-6TP21	6, 2 Frames	(4) 2" x 10" *Treated #1 Southern Yellow Pine Planks	137
B302/CB-8TP21		B302/G-8TP21	8, 2 Frames	160		\$478.00
B303/CB-12TP21		B303/G-12TP21	12, 3 Frames	286		\$716.00
B303/CB-15TP21		B303/G-15TP21	15, 3 Frames	332	\$826.00	
B302/CB-6AL		B302/G-6AL	6, 2 Frames	(4) 2" x 10" *Clear Anodized Aluminum Planks	116	\$878.00
B302/CB-8AL		B302/G-8AL	8, 2 Frames		132	\$1,084.00
B303/CB-12AL		B303/G-12AL	12, 3 Frames		197	\$1,624.00
B303/CB-15AL		B303/G-15AL	15, 3 Frames		221	\$1,933.00
B304/CB-21AL		B304/G-21AL	21, 4 Frames		302	\$2,678.00
B302/CB-6AR		B302/G-6AR	6, 2 Frames	(4) 2" x 10" *Red Powder Coated Aluminum Planks	116	\$878.00
B302/CB-8AR		B302/G-8AR	8, 2 Frames		132	\$1,084.00
B303/CB-12AR		B303/G-12AR	12, 3 Frames		197	\$1,624.00



ATHLETIC BENCH -Round Post -AB Series (Catalog Page 21)	Powder Coated Frames, Black standard */(CB) Model No.	Hot-Dip Galvanized Frames (/G) Model No.	Length (ft.)	Material	Wt. (lbs.)	Price	
	Flat Bench, 2-3/8" O.D. steel pipe frame post and portable foot (PAB), 3/16" thick steel seat angle. SAB: embedded installation PAB: portable/surface mount SAB/P: stationary surface mount with base plate	SAB/CB-4TP21	SAB/G-4TP21	4	(1) 2" x 10" *Treated #1 Southern Yellow Pine Plank	38	\$276.00
SAB/CB-6TP21		SAB/G-6TP21	6	45		\$287.00	
SAB/CB-8TP21		SAB/G-8TP21	8	53		\$303.00	
SAB3/CB-15TP21		SAB3/G-15TP21	15, 3 Frames	90		\$475.00	
PAB/CB-4TP21		PAB/G-4TP21	4	37		\$276.00	
PAB/CB-6TP21		PAB/G-6TP21	6	51		\$287.00	
PAB/CB-8TP21		PAB/G-8TP21	8	60		\$303.00	
PAB3/CB-15TP21		PAB3/G-15TP21	15, 3 Frames	105		\$475.00	
SAB/P/CB-4TP21		SAB/P/G-4TP21	4	38		\$276.00	
SAB/P/CB-6TP21		SAB/P/G-6TP21	6	45		\$287.00	
SAB/P/CB-8TP21		SAB/P/G-8TP21	8	53	\$303.00		
SAB3/P/CB-15TP21		SAB3/P/G-15TP21	15, 3 Frames	90	\$475.00		
SAB/CB-4AL		SAB/G-4AL	4	(1) 2" x 10" *Clear Anodized Aluminum Plank	30	\$352.00	
SAB/CB-6AL		SAB/G-6AL	6		33	\$403.00	
SAB/CB-8AL		SAB/G-8AL	8		36	\$455.00	
SAB3/CB-15AL		SAB3/G-15AL	15, 3 Frames		60	\$759.00	
SAB5/CB-21AL		SAB5/G-21AL	21, 5 Frames		118	\$984.00	
SAB5/CB-24AL		SAB5/G-24AL	24, 5 Frames		127	\$1,062.00	
PAB/CB-4AL		PAB/G-4AL	4		29	\$352.00	
PAB/CB-6AL		PAB/G-6AL	6		39	\$403.00	
PAB/CB-8AL		PAB/G-8AL	8		43	\$455.00	
PAB3/CB-15AL		PAB3/G-15AL	15, 3 Frames		75	\$759.00	
PAB5/CB-21AL		PAB5/G-21AL	21, 5 Frames		143	\$984.00	
PAB5/CB-24AL		PAB5/G-24AL	24, 5 Frames		152	\$1,062.00	
SAB/P/CB-4AL		SAB/P/G-4AL	4		30	\$352.00	
SAB/P/CB-6AL		SAB/P/G-6AL	6		33	\$403.00	
SAB/P/CB-8AL		SAB/P/G-8AL	8		36	\$455.00	
SAB3/P/CB-15AL		SAB3/P/G-15AL	15, 3 Frames		60	\$759.00	
SAB5/P/CB-21AL		SAB5/P/G-21AL	21, 5 Frames		118	\$984.00	
SAB5/P/CB-24AL		SAB5/P/G-24AL	24, 5 Frames		127	\$1,062.00	
SAB/CB-4AR		SAB/G-4AR	4		(1) 2" x 10" *Red Powder Coated Aluminum Plank	30	\$352.00
SAB/CB-6AR		SAB/G-6AR	6			33	\$403.00
SAB/CB-8AR		SAB/G-8AR	8	36		\$455.00	
PAB/CB-4AR		PAB/G-4AR	4	29		\$352.00	
PAB/CB-6AR		PAB/G-6AR	6	39		\$403.00	
PAB/CB-8AR	PAB/G-8AR	8	43	\$455.00			
SAB/P/CB-4AR	SAB/P/G-4AR	4	30	\$352.00			
SAB/P/CB-6AR	SAB/P/G-6AR	6	33	\$403.00			
SAB/P/CB-8AR	SAB/P/G-8AR	8	36	\$455.00			

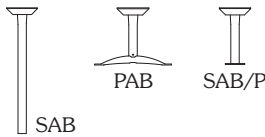

ATHLETIC BENCH - AB Series ... continued on Page 9

*See Pages 57 – 59 for optional lumber species, material color options, and the character designators to specify those options in the Model Numbers.

ATHLETIC BENCH - Round Post - AB Series (Catalog Page 21) ... continued Flat Bench, 2-3/8" O.D. steel pipe frame post and portable foot (PAB), 3/16" thick steel seat angle. SAB: embedded installation PAB: portable/surface mount SAB/P: stationary surface mount with base plate	Powder Coated Frames, Black standard */(CB) Model No.	Hot-Dip Galvanized Frames (/G) Model No.	Length (ft.)	Material	Wt. (lbs.)	Price
		SAB/CB-4VW10	SAB/G-4VW10	4	(1) 2" x 10" *Brown Thermo-plastic Coated Expanded Steel Plank	40
SAB/CB-6VW10		SAB/G-6VW10	6	52		\$461.00
SAB/CB-8VW10		SAB/G-8VW10	8	59		\$497.00
PAB/CB-4VW10		PAB/G-4VW10	4	39		\$389.00
PAB/CB-6VW10		PAB/G-6VW10	6	58		\$461.00
PAB/CB-8VW10		PAB/G-8VW10	8	66		\$497.00
SAB/P/CB-4VW10		SAB/P/G-4VW10	4	40		\$389.00
SAB/P/CB-6VW10		SAB/P/G-6VW10	6	52		\$461.00
SAB/P/CB-8VW10		SAB/P/G-8VW10	8	59		\$497.00
SAB/CB-4VW12		SAB/G-4VW12	4	(1) 2" x 12" *Brown Thermo-plastic Coated Expanded Steel Plank	44	\$450.00
SAB/CB-6VW12		SAB/G-6VW12	6		56	\$488.00
SAB/CB-8VW12		SAB/G-8VW12	8		63	\$518.00
PAB/CB-4VW12		PAB/G-4VW12	4		43	\$450.00
PAB/CB-6VW12		PAB/G-6VW12	6		62	\$488.00
PAB/CB-8VW12		PAB/G-8VW12	8		70	\$518.00
SAB/P/CB-4VW12		SAB/P/G-4VW12	4		44	\$450.00
SAB/P/CB-6VW12		SAB/P/G-6VW12	6		56	\$488.00
SAB/P/CB-8VW12		SAB/P/G-8VW12	8		63	\$518.00
SAB/CB-4HW10		SAB/G-4HW10	4	(1) 2" x 10" *Brown Thermo-plastic Coated Perforated Steel Plank	42	\$394.00
SAB/CB-6HW10		SAB/G-6HW10	6		54	\$472.00
SAB/CB-8HW10		SAB/G-8HW10	8		63	\$525.00
PAB/CB-4HW10		PAB/G-4HW10	4		41	\$394.00
PAB/CB-6HW10		PAB/G-6HW10	6		60	\$472.00
PAB/CB-8HW10		PAB/G-8HW10	8		70	\$525.00
SAB/P/CB-4HW10		SAB/P/G-4HW10	4		42	\$394.00
SAB/P/CB-6HW10		SAB/P/G-6HW10	6		54	\$472.00
SAB/P/CB-8HW10		SAB/P/G-8HW10	8		63	\$525.00
SAB/CB-4HW12		SAB/G-4HW12	4	(1) 2" x 12" *Brown Thermo-plastic Coated Perforated Steel Plank	48	\$454.00
SAB/CB-6HW12		SAB/G-6HW12	6		57	\$503.00
SAB/CB-8HW12		SAB/G-8HW12	8		67	\$554.00
PAB/CB-4HW12		PAB/G-4HW12	4		47	\$454.00
PAB/CB-6HW12		PAB/G-6HW12	6		63	\$503.00
PAB/CB-8HW12		PAB/G-8HW12	8		74	\$554.00
SAB/P/CB-4HW12	SAB/P/G-4HW12	4	48		\$454.00	
SAB/P/CB-6HW12	SAB/P/G-6HW12	6	57		\$503.00	
SAB/P/CB-8HW12	SAB/P/G-8HW12	8	67		\$554.00	
SAB/CB-6SC/TW	SAB/G-6SC/TW	6	(1) 2" x 11" *Brown Thermo-plastic Coated Formed Steel Channel Plank	70	\$489.00	
SAB/CB-8SC/TW	SAB/G-8SC/TW	8		87	\$539.00	
PAB/CB-6SC/TW	PAB/G-6SC/TW	6		76	\$489.00	
PAB/CB-8SC/TW	PAB/G-8SC/TW	8		94	\$539.00	
SAB/P/CB-6SC/TW	SAB/P/G-6SC/TW	6		70	\$489.00	
SAB/P/CB-8SC/TW	SAB/P/G-8SC/TW	8		87	\$539.00	

*See Pages 57 – 59 for optional lumber species, material color options, and the character designators to specify those options in the Model Numbers.

ATHLETIC BENCH - Rectangular Post - APB Series (Catalog Page 21)	Powder Coated Frames, Black standard */(CB) Model No.	Hot-Dip Galvanized Frames */(G) Model No.	Length (ft.)	Material	Wt. (lbs.)	Price
	Flat Bench, 3" x 6" x 1/8" wall, rectangular steel tube frame posts, 2" x 3" x 3/16" thick steel seat angles. APB: embedded installation APB/P: base plate surface mount	APB/CB-4TP21	APB/G-4TP21	4	(1) 2" x 10" *Treated #1 Southern Yellow Pine Plank	60
APB/CB-6TP21		APB/G-6TP21	6	68		\$290.00
APB/CB-8TP21		APB/G-8TP21	8	76		\$306.00
APB/P/CB-4TP21		APB/P/G-4TP21	4	60		\$278.00
APB/P/CB-6TP21		APB/P/G-6TP21	6	68		\$290.00
APB/P/CB-8TP21		APB/P/G-8TP21	8	76		\$306.00
APB/CB-4AL		APB/G-4AL	4	(1) 2" x 10" *Clear Anodized Aluminum Plank	52	\$359.00
APB/CB-6AL		APB/G-6AL	6		56	\$389.00
APB/CB-8AL		APB/G-8AL	8		60	\$432.00
APB/P/CB-4AL		APB/P/G-4AL	4		52	\$359.00
APB/P/CB-6AL		APB/P/G-6AL	6		56	\$389.00
APB/P/CB-8AL		APB/P/G-8AL	8		60	\$432.00
APB/CB-4AR		APB/G-4AR	4	(1) 2" x 10" *Red Powder Coated Aluminum Plank	52	\$359.00
APB/CB-6AR		APB/G-6AR	6		56	\$389.00
APB/CB-8AR		APB/G-8AR	8		60	\$432.00
APB/P/CB-4AR		APB/P/G-4AR	4		52	\$359.00
APB/P/CB-6AR		APB/P/G-6AR	6		56	\$389.00
APB/P/CB-8AR		APB/P/G-8AR	8		60	\$432.00
APB/CB-4PC21		APB/G-4PC21	4	(1) 2" x 10" *Cedar colored Recycled Plastic Plank	66	\$310.00
APB/CB-6PC21		APB/G-6PC21	6		88	\$408.00
APB/CB-8PC21		APB/G-8PC21	8		101	\$486.00
APB/P/CB-4PC21		APB/P/G-4PC21	4		66	\$310.00
APB/P/CB-6PC21		APB/P/G-6PC21	6		88	\$408.00
APB/P/CB-8PC21		APB/P/G-8PC21	8		101	\$486.00
APB/CB-4VW10		APB/G-4VW10	4	(1) 2" x 10" *Brown Thermo-plastic Coated Expanded Steel Plank	62	\$397.00
APB/CB-6VW10		APB/G-6VW10	6		74	\$468.00
APB/CB-8VW10		APB/G-8VW10	8		81	\$505.00
APB/P/CB-4VW10		APB/P/G-4VW10	4		62	\$397.00
APB/P/CB-6VW10		APB/P/G-6VW10	6		74	\$468.00
APB/P/CB-8VW10		APB/P/G-8VW10	8		81	\$505.00
APB/CB-4VW12		APB/G-4VW12	4	(1) 2" x 12" *Brown Thermo-plastic Coated Expanded Steel Plank	66	\$458.00
APB/CB-6VW12		APB/G-6VW12	6		78	\$495.00
APB/CB-8VW12	APB/G-8VW12	8	85		\$524.00	
APB/P/CB-4VW12	APB/P/G-4VW12	4	66		\$458.00	
APB/P/CB-6VW12	APB/P/G-6VW12	6	78		\$495.00	
APB/P/CB-8VW12	APB/P/G-8VW12	8	85		\$524.00	
APB/CB-4HW10	APB/G-4HW10	4	(1) 2" x 10" *Brown Thermo-plastic Coated Perforated Steel Plank	64	\$400.00	
APB/CB-6HW10	APB/G-6HW10	6		76	\$480.00	
APB/CB-8HW10	APB/G-8HW10	8		85	\$535.00	
APB/P/CB-4HW10	APB/P/G-4HW10	4		64	\$400.00	
APB/P/CB-6HW10	APB/P/G-6HW10	6		76	\$480.00	
APB/P/CB-8HW10	APB/P/G-8HW10	8		85	\$535.00	
APB/CB-4HW12	APB/G-4HW12	4	(1) 2" x 12" *Brown Thermo-plastic Coated Perforated Steel Plank	70	\$463.00	
APB/CB-6HW12	APB/G-6HW12	6		79	\$510.00	
APB/CB-8HW12	APB/G-8HW12	8		89	\$565.00	
APB/P/CB-4HW12	APB/P/G-4HW12	4		70	\$463.00	
APB/P/CB-6HW12	APB/P/G-6HW12	6		79	\$510.00	
APB/P/CB-8HW12	APB/P/G-8HW12	8		89	\$565.00	
APB/CB-6SC/TW	APB/G-6SC/TW	6	(1) 2" x 11" *Brown Thermo-plastic Coated Formed Steel Channel Plank	96	\$511.00	
APB/CB-8SC/TW	APB/G-8SC/TW	8		102	\$562.00	
APB/P/CB-6SC/TW	APB/P/G-6SC/TW	6		96	\$511.00	
APB/P/CB-8SC/TW	APB/P/G-8SC/TW	8		102	\$562.00	

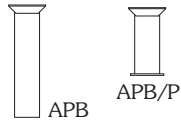

*See Pages 57 – 59 for optional lumber species, material color options, and the character designators to specify those options in the Model Numbers.

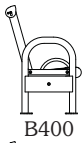

B400

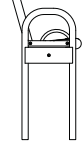

B401

SIGN BENCH - Contour Seating - B400 and B401 Series (Catalog Page 22)	Powder Coated Frames, Black standard */(CB) Model No.	Length (ft.)	Number of Seat Dividers	Material	Sign Size (H x W)	Wt. (lbs.)	Price
	Contour Bench, surface or embedded mount. All-welded 2-3/8" O.D. steel pipe frames and armrests with steel plates for custom decals. 10 ga. cut steel plate seat and sign frame. Black painted, 3/4" MDO board for sign back support. Sign not included -see Optional Signs below B400: surface mount B401: embedded installation	B400/CB-4SP/TB	4	0	*Black Thermo-plastic Coated 10 ga. Cut Steel Plate	24" x 48"	116
B400/CB-6SP/TB		6	2	24" x 72"		174	\$851.00
B400/CB-8SP/TB		8	3	24" x 96"		231	\$927.00
B401/CB-4SP/TB		4	0	24" x 48"		116	\$776.00
B401/CB-6SP/TB		6	2	24" x 72"		174	\$851.00
B401/CB-8SP/TB		8	3	24" x 96"		231	\$927.00

Optional SIGNS for B400 and B401 Series SIGN BENCHES				
Model No.	Size	Material	Wt. (lbs.)	Price
SIGN BCH24X48	24" x 48"	Sign material is .040" ga. Alumilite aluminum laminate with 1/4" thick polycarbonate core, a 3M vinyl digitally printed graphic material, and a 3M protective lamination over the graphic.	4	\$267.00
SIGN BCH24X72	24" x 72"		6	\$310.00
SIGN BCH24X96	24" x 96"		8	\$365.00

SIGN BENCH - Classic Seating - B410, B411, and B412 Series
(Catalog Page 23)

Bench with Back, 2-3/8" O.D. steel pipe frame post and portable foot (B410), 1/8" thick (11 ga.) die-formed seat and back channel. Black painted, 3/4" MDO board for sign back support.
Sign not included -see Optional Signs below
B410: portable/surface mount
B411: embedded installation
B412: stationary surface mount with base plate



B410



B411



B412

SIGN BENCH - Classic Seating - B410, B411, and B412 Series (Catalog Page 23)	Powder Coated Frames, Black standard */(CB) Model No.	Hot-Dip Galvanized Frames (G) Model No.	Length (ft.)	Material	Sign Size (H x W)	Wt. (lbs.)	Price
	Bench with Back, 2-3/8" O.D. steel pipe frame post and portable foot (B410), 1/8" thick (11 ga.) die-formed seat and back channel. Black painted, 3/4" MDO board for sign back support. Sign not included -see Optional Signs below B410: portable/surface mount B411: embedded installation B412: stationary surface mount with base plate	B410/CB-4VB	B410/G-4VB	4	(1) 2" x 12" *Black Thermo-plastic Coated Expanded Steel Plank	16" x 48"	70
B410/CB-6VB		B410/G-6VB	6	16" x 72"		103	\$472.00
B410/CB-8VB		B410/G-8VB	8	16" x 96"		142	\$568.00
B411/CB-4VB		B411/G-4VB	4	16" x 48"		70	\$419.00
B411/CB-6VB		B411/G-6VB	6	16" x 72"		103	\$472.00
B411/CB-8VB		B411/G-8VB	8	16" x 96"		142	\$568.00
B412/CB-4VB		B412/G-4VB	4	16" x 48"		70	\$419.00
B412/CB-6VB		B412/G-6VB	6	16" x 72"		103	\$472.00
B412/CB-8VB		B412/G-8VB	8	16" x 96"		142	\$568.00
B410/CB-4HB		B410/G-4HB	4	(1) 2" x 12" *Black Thermo-plastic Coated Perforated Steel Plank	16" x 48"	70	\$419.00
B410/CB-6HB		B410/G-6HB	6		16" x 72"	104	\$472.00
B410/CB-8HB		B410/G-8HB	8		16" x 96"	146	\$568.00
B411/CB-4HB		B411/G-4HB	4		16" x 48"	70	\$419.00
B411/CB-6HB		B411/G-6HB	6		16" x 72"	104	\$472.00
B411/CB-8HB		B411/G-8HB	8		16" x 96"	146	\$568.00
B412/CB-4HB		B412/G-4HB	4		16" x 48"	70	\$419.00
B412/CB-6HB		B412/G-6HB	6		16" x 72"	104	\$472.00
B412/CB-8HB		B412/G-8HB	8		16" x 96"	146	\$568.00
B410/CB-6SC/TB		B410/G-6SC/TB	6	(1) 2" x 11" *Black Thermo-plastic Coated Formed Steel Channel Seat Plank	16" x 72"	114	\$472.00
B410/CB-8SC/TB		B410/G-8SC/TB	8		16" x 96"	153	\$568.00
B411/CB-6SC/TB		B411/G-6SC/TB	6		16" x 72"	114	\$472.00
B411/CB-8SC/TB		B411/G-8SC/TB	8		16" x 96"	153	\$568.00
B412/CB-6SC/TB		B412/G-6SC/TB	6		16" x 72"	114	\$472.00
B412/CB-8SC/TB		B412/G-8SC/TB	8		16" x 96"	153	\$568.00

Optional SIGNS for B410, B411, and B412 Series SIGN BENCHES				
Model No.	Size	Material	Wt. (lbs.)	Price
SIGN BCH16X48	16" x 48"	Sign material is .040" ga. Alumilite aluminum laminate with 1/4" thick polycarbonate core, a 3M vinyl digitally printed graphic material, and a 3M protective lamination over the graphic.	3	\$228.00
SIGN BCH16X72	16" x 72"		4	\$267.00
SIGN BCH16X96	16" x 96"		6	\$310.00

*See Pages 57 - 59 for optional lumber species, material color options, and the character designators to specify those options in the Model Numbers.

BENCH FRAMES ONLY			Prices are for both Hot-Dip Galvanized and Powder Coat finished models.	
Frame only Kits include frame units, all fasteners, and diagonal braces for portable benches. Replace the ▲ with the number for the desired bench length.				
Model No.	Length (ft.)	Use with	Wt. (lbs.)	Price
SCXB-▲FR	4, 6, 8	Lumber, Aluminum,	29	\$248.00
PCXB-4FR	4	Expanded Steel,	35	
PCXB-6FR	6	Perforated Steel,	37	
PCXB-8FR	8	Steel Channel	39	
SCXB3-10FR	10, 3 frames	Expanded Steel, Perforated Steel	44	\$372.00
SCXB4-16FR	16, 4 frames		58	\$496.00
PCXB3-10FR	10, 3 frames		56	\$372.00
PCXB4-16FR	16, 4 frames		78	\$496.00
SCXB3-15FR	15, 3 frames	Lumber, Aluminum	44	\$372.00
PCXB3-15FR	15, 3 frames		53	\$372.00
SCXB5-21FR	21, 5 frames	Aluminum	73	\$620.00
SCXB5-24FR	24, 5 frames		73	
PCXB5-21FR	21, 5 frames		88	
PCXB5-24FR	24, 5 frames		88	
SCXB-4FR	4	Recycled Plastic	29	\$248.00
SCXB3-6FR	6, 3 frames		44	\$372.00
PCXB-4FR	4		35	\$248.00
PCXB3-6FR	6, 3 frames		53	\$372.00
B110C-6FR	6, 3 frames	Lumber, Recycled Plastic	65	\$433.00
B111C-6FR	6, 3 frames		65	\$433.00
CLB/G-4FR	4	Lumber	24	\$137.00
CLB/G-6FR	6		29	\$170.00
CLB/G-4FRP	4	Recycled Plastic	26	\$210.00
CLB3/G-6FRP	6, 3 frames		39	\$277.00
SWRB-▲FR	4, 6, 8	Lumber	50	\$394.00
PWRB-▲FR	4, 6, 8		56	\$394.00
SWRB-4FR	4	Recycled Plastic	50	\$394.00
SWRB3-▲FR	6, 8; 3 frames		75	\$588.00
PWRB-4FR	4		56	\$394.00
PWRB3-▲FR	6, 8; 3 frames		84	\$588.00
OWRB-4FR	4	Lumber	61	\$464.00
OWRB-6FR	6		65	\$492.00
OWRB/P-4FR	4		61	\$464.00
OWRB/P-6FR	6		65	\$492.00
OWRB-4FR	4		61	\$464.00
OWRB3-6FRP	6, 3 Supports		80	\$492.00
OWRB/P-4FR	4	Recycled Plastic	61	\$464.00
OWRB3/P-6FRP	6, 3 Supports		80	\$492.00
SWB-▲FR	4, 6, 8	Lumber	34	\$305.00
PWB-▲FR	4, 6, 8		38	\$305.00
SWB-4FR	4	Recycled Plastic	34	\$305.00
SWB3-▲FR	6, 8; 3 frames		51	\$457.00
PWB-4FR	4		38	\$305.00
PWB3-▲FR	6, 8; 3 frames		57	\$457.00

BENCH FRAMES ONLY ... continued			Prices are for both Hot-Dip Galvanized and Powder Coat finished models.	
Frame only Kits include frame units, all fasteners, and diagonal braces for portable benches. Replace the ▲ with the number for the desired bench length.				
Model No.	Length (ft.)	Use with	Wt. (lbs.)	Price
OWB-4FR	4	Lumber	54	\$420.00
OWB-6FR	6		58	\$448.00
OWB/P-4FR	4		54	\$420.00
OWB/P-6FR	6		58	\$448.00
OWB-4FR	4	Recycled Plastic	54	\$420.00
OWB3-6FRP	6, 3 Supports		63	\$448.00
OWB/P-4FR	4		54	\$420.00
OWB3/P-6FRP	6, 3 Supports		63	\$448.00
WMB-4FR	4	Lumber, Aluminum, Expanded Steel, Perforated Steel, Steel Channel	8	\$85.00
WMB3-▲FR	6, 8; 3 brackets		12	\$127.00
WMB-4FR	4	Recycled Plastic	8	\$85.00
WMB3-6FR	6; 3 brackets		12	\$127.00
WMB4-8FR	8; 4 brackets		16	\$169.00
B302-6FR	6, 2 frames	Lumber, Aluminum	68	\$259.00
B302-8FR	8, 2 frames		68	\$259.00
B303-12FR	12, 3 frames		102	\$387.00
B303-15FR	15, 3 frames		102	\$387.00
B304-21FR	21, 4 frames	Aluminum	136	\$514.00
SAB-▲FR	4, 6, 8	Lumber, Aluminum, Expanded Steel, Perforated Steel, Steel Channel	22	\$178.00
PAB-4FR	4		21	\$178.00
PAB-6FR	6		28	
PAB-8FR	8		29	
SAB/P-▲FR	4, 6, 8		22	\$178.00
SAB3-15FR	15, 3 frames	Lumber, Aluminum	33	\$267.00
PAB3-15FR	15, 3 frames		48	\$267.00
SAB3/P-15FR	15, 3 frames		33	\$267.00
SAB5-21FR	21, 5 frames	Aluminum	55	\$443.00
SAB5-24FR	24, 5 frames		55	
PAB5-21FR	21, 5 frames		80	\$443.00
PAB5-24FR	24, 5 frames		80	
SAB5/P-21FR	21, 5 frames		55	
SAB5/P-24FR	24, 5 frames		55	
APB-▲FR	4, 6, 8	Lumber, Aluminum, Expanded Steel, Perforated Steel, Steel Channel	44	\$208.00
APB/P-▲FR	4, 6, 8		44	\$208.00
APB-4FR	4	Recycled Plastic	44	\$208.00
APB-6FRP	6		55	\$240.00
APB-8FRP	8		58	\$248.00
APB/P-4FR	4		44	\$208.00
APB/P-6FRP	6		55	\$240.00
APB/P-8FRP	8		58	\$248.00

ACCESSORIES for BENCHES

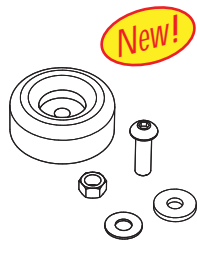

New!

BENCH FOOT PADS			
Foot Pad of durable, tear resistant black rubber; 2-1/2" diameter x 1" high; recessed center for fasteners; includes 3/8" x 1-1/4" Stainless Steel Button Head Bolt, Flat Washer, and Nut, and Rubber Flat Washer; 7/32 Allen Wrench required for assembly (not included)			
Bench Foot Pads fit on these Portable Bench Models: PCXB Channel Benches, B120 and B122 Contemporary Benches; B110C Accessible Benches; B40 and B42 Silver Sioux Benches; PAB Athletic Benches; and B410 Sign Benches			
Model No.	Description	Wt. (lbs.)	Price
BFP1-2	Set of 2 Bench Foot Pads, includes fasteners	1	\$6.00
BFP1-4	Set of 4 Bench Foot Pads, includes fasteners	2	\$12.00

*See Pages 57 – 59 for optional lumber species, material color options, and the character designators to specify those options in the Model Numbers.

RJ Thomas Mfg. Co., Inc.

P.O. Box 946 • Cherokee, Iowa 51012-0946 • ORDERS Toll Free: 800-762-5002 • FAX: 712-225-5796 • 712-225-5115

CUSTOM SIGNAGE - for Benches, Tables, and Trash Receptacles (Catalog Pages 24 & 25)		
Signage Option	Description	Price
ENGRAVED and RESIN FILLED LETTERS	Custom engraved lettering on Recycled Plastic up to a maximum height of 3" per letter (for larger letters, please inquire). May be filled with colored resin. A drawing of the layout will be provided for approval.	
	Set-up Charge per unique line of text on a board (if text changes another charge applies)	\$35.00
	Cost per 3" Routed Letter, in addition to the initial Set-up Charge (for larger letters, please inquire)	\$6.00
	Cost per 3" Routed Letter with Colored Resin Fill, in addition to the initial Set-up Charge (for larger letters, please inquire)	\$12.00
LAMINATE PLAQUES	Plaques of laminated impact acrylic, 3 ply thick (1/8"), up to 2-1/2" high x 11-3/4" wide to fit most bench applications (for larger sizes, please inquire). May include laser engraved graphics and photos. Artwork for the design will be provided for approval. Surface and core color combinations include, but are not limited to (surface/core): Black/Gold, Black/White, or Beige/Chocolate Brown. Other color combinations may be available, please inquire. Plaques for Steel Strap or Cut Steel Plate benches: Priced on Request. Artwork for the design will be provided for approval.	
	Model No.: PLAQUE-1 -Text only, Standard size 2-1/2" high x 11-3/4" wide	\$86.00
	Model No.: PLAQUE-1LG -Text with Laser Engraved Graphics, Standard size 2-1/2" high x 11-3/4" wide	\$131.00
METAL PLAQUES	Round or Rectangular. Silver or bronze colored border and raised letters and can include standard decorative elements. Baked-on enamel background is lightly textured and available in choice of 4 colors: Black, Brown, Maroon, and Green. Please specify color. Round Plaques are available on Steel Strap or Cut Steel Plate Contour Benches. Artwork will be provided for approval. Rectangular Plaques are available on most Benches with Lumber or Recycled Plastic boards. Artwork will be provided for approval.	
	Model No.: PLAQUE-2RD -Round, 6" diameter. Raised letters and standard decorative elements.	\$274.00
	Model No.: PLAQUE-2RT -Rectangular, 2-1/2" high x 11-3/4" wide. Raised letters and standard decorative elements.	\$263.00
	Model No.: PLAQUE-2RDG -Round, 6" diameter. Including custom raised graphics.	\$334.00
Model No.: PLAQUE-2RTG -Rectangular, 2-1/2" high x 11-3/4" wide. Including custom raised graphics.	\$323.00	
PERFORATED STEEL SIGNAGE	Model No.: LETTERS-2 -Custom lettering incorporated into Perforated Steel Benches (2" x 12" planks only), Tables, or Receptacles and Thermo-plastic coated in specified color (number and size of letters is limited). A drawing of the layout will be provided for approval. Price is for each order for each distinct message on a specific Model of Bench, Table, or Receptacle.	\$255.00
CUT STEEL SIGNAGE	Model No.: LETTERS-1 -Custom lettering or graphic silhouettes cut into the Cut Steel Plate on Benches. Coated finish. A drawing of the layout will be provided for approval. Price is for each Bench.	\$255.00

ARMRESTS for select Benches (Catalog Page 26)	Powder Coated Frames Model No.	Hot-Dip Galvanized Frames (G) Model No.	Bench Series used on	Pad Material	Wt. (lbs.)	Price
Bolt-on 3/16" x 2" steel frame Armrests available for CXB Series Channel Bench, WRB and OWRB Series Contour Benches, and WB and OWB Series Trail-side Benches. Bolt-on Cast Iron Armrest available for B94 Oak Knoll Bench with Steel Strap or Steel Plate seat designs. Bolt-on 2-3/8" O.D. steel pipe Armrests available for B78 and B79 Series Riverview Benches.	AR/◆-1TP	AR/G-1TP	CXB -2" x 4" or 2" x 10" Lumber	(1) 2" x 4" *Treated Pine Slat	5	\$44.00
	AR/◆-4CO	AR/G-4CO	WRB, OWRB -3" x 4" Lumber	(1) 2" x 4" *Construction Heart Redwood Slat	5	\$44.00
	AR/◆-6CO	AR/G-6CO	WB, OWB -3" x 4" Lumber		5	\$44.00
	AR/◆-1PC	AR/G-1PC	CXB -2" x 4" or 2" x 10" Recycled Plastic	(1) 2" x 4" *Cedar colored Recycled Plastic Slat	5	\$44.00
	AR/◆-4PC	AR/G-4PC	WRB, OWRB -3" x 4" Recycled Plastic		5	\$44.00
	AR/◆-6PC	AR/G-6PC	WB, OWB -3" x 4" Recycled Plastic		5	\$44.00
	AR/◆-10	NA	B94 Oak Knoll -Steel Strap or Steel Plate	NA	6	\$114.00
	AR/◆-13	NA	B78, B79 -Expanded or Perforated Steel	NA	7	\$64.00

◆ See Page 56 for Powder Coat color choices to match bench frames.

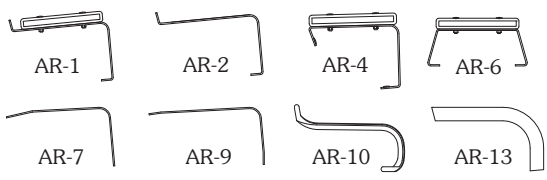

Thermo-plastic Coated Armrest Frames			
◆ See Page 57 for color choices to match Thermo-plastic Coated bench planks.			
Model No.	Bench Series used on	Wt. (lbs.)	Price
AR/◆-2	CXB with 2" x 10" or 2" x 12" Perforated Steel Planks	4	\$42.00
AR/◆-7	CXB with 2" x 10" Expanded Steel Planks	4	\$42.00
AR/◆-9	CXB with 2" x 12" Expanded Steel Planks	4	\$42.00

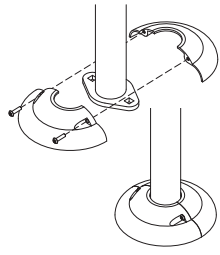

Note:
Cover Caps are not available on products with Thermo-plastic coating.

COVER CAPS (Catalog Page 26)			
Cover Caps of Cast Aluminum with no coating, two-part, bolt-together requiring 5/32 Allen Wrench to assemble (not included), 2-1/2" dia. center hole fits all 2-3/8" O.D. frame posts, 8" O.D. at the base, Optional *Powder Coat Finish available.			
Cover Caps fit on these products:			
Benches: Model Series: B400, B401, B411, and B412 Sign Benches; SCXB Channel Benches, B121 and B123 Contemporary Benches; B111C Accessible Benches; B41 and B43 Silver Sioux Benches; B60, B61, B62, B63, B76, B77, B78, and B79 Riverview Benches; SAB and SAB/P Athletic Benches			
Tables: Model Series: T600 Caterpillar Tables; FCT Food Court Tables			
Trash Receptacles: CN-TR-52 Tilting Trash Receptacle (embedded post), M2 and M8 Receptacle Mounts (embedded post)			
Bike Racks: Model Series: HRE and HRP Hitching Post Bike Racks, SRE and SRP Saddleback Bike Racks			
Lantern Poles: Model Series: LH-1, LH-2, LH-180			
Park Grills: Models ASWS-20 B6S, ASWS-24 B6S, J-20 B6, NS-20 B6S, H-16 B6, H-16 B6X2, GS-5 Grill Station			
Model No.	Description	Wt. (lbs.)	Price
CC-1	1 Cover Cap (2 Halves), no coating, with fasteners	1	\$37.00
CC/CB-1	1 Cover Cap (2 Halves), *Powder Coated Black Finish (/CB), with fasteners		

*See Pages 57 - 59 for optional lumber species, material color options, and the character designators to specify those options in the Model Numbers.

PARK TABLES

HEAVY DUTY TABLE -UT Series (Catalog Page 28)	Powder Coated Frames, Black standard */(CB) Model No.	Hot-Dip Galvanized Frames (/G) Model No.	Length (ft.)	Material	Wt. (lbs.)	Price
	UT/CB-6UP	UT/G-6UP				
1-5/8" O.D. steel pipe frames (1.66" O.D., 11 ga. wall, 1-1/4" I.D. nom. pipe specifications), 2" x 2" x 1/8" die-formed steel top and seat angles, 1-5/16" O.D. steel pipe diagonal braces, portable.	UT/CB-6UP	UT/G-6UP	6	*Untreated #1 Southern Yellow Pine	191	\$482.00
	UT/CB-8UP	UT/G-8UP	8		231	\$542.00
	UT/CB-10UP	UT/G-10UP	10		306	\$752.00
	UT/CB-12UP	UT/G-12UP	12		347	\$810.00
	UT/CB-6TP	UT/G-6TP	6	*Treated #1 Southern Yellow Pine	191	\$492.00
	UT/CB-8TP	UT/G-8TP	8		231	\$554.00
	UT/CB-10TP	UT/G-10TP	10		306	\$770.00
	UT/CB-12TP	UT/G-12TP	12		347	\$831.00
	UT/CB-6AL	UT/G-6AL	6	Clear Anodized Aluminum	136	\$1,080.00
	UT/CB-8AL	UT/G-8AL	8		157	\$1,338.00
	UT/CB-10AL	UT/G-10AL	10		213	\$1,749.00
	UT/CB-12AL	UT/G-12AL	12		236	\$2,007.00
	UT/CB-6AR	UT/G-6AR	6	*Red Powder Coated Aluminum	136	\$1,080.00
	UT/CB-8AR	UT/G-8AR	8		157	\$1,338.00
	UT/CB-10AR	UT/G-10AR	10		213	\$1,749.00
	UT/CB-12AR	UT/G-12AR	12		236	\$2,007.00
	UT/CB-6PC	UT/G-6PC	6	*Cedar colored Recycled Plastic	275	\$1,026.00
	UT/CB-8PC	UT/G-8PC	8		341	\$1,246.00
	UT4/CB-10PC	UT4/G-10PC	10, 4 Frames		395	\$1,634.00
	UT/CB-6DW	UT/G-6DW	6	*Brown D-Type Thermo-plastic Coated Expanded Steel	190	\$1,046.00
UT/CB-8DW	UT/G-8DW	8	222		\$1,189.00	
UT/CB-10DW	UT/G-10DW	10	292		\$1,553.00	
UT/CB-6RW	UT/G-6RW	6	*Brown R-Type Thermo-plastic Coated Perforated Steel	191	\$1,177.00	
UT/CB-8RW	UT/G-8RW	8		243	\$1,262.00	
UT/CB-10RW	UT/G-10RW	10		308	\$1,711.00	
UT/CB-6SC/TW	UT/G-6SC/TW	6	*Brown Thermo-plastic Coated Formed Steel Channel	243	\$1,205.00	
UT/CB-8SC/TW	UT/G-8SC/TW	8		283	\$1,367.00	



EXTRA HEAVY DUTY TABLE -XT Series (Catalog Page 29)	Powder Coated Frames, Black standard */(CB) Model No.	Hot-Dip Galvanized Frames (/G) Model No.	Length (ft.)	Material	Wt. (lbs.)	Price
	XT/CB-6UP	XT/G-6UP				
2-3/8" O.D. steel pipe frames (2.375" O.D., 11 ga. wall, 2" I.D. nom. pipe specifications), 2" x 2" x 1/8" die-formed steel top and seat angles, 1-5/16" O.D. steel pipe diagonal braces, portable.	XT/CB-6UP	XT/G-6UP	6	*Untreated #1 Southern Yellow Pine	218	\$567.00
	XT/CB-8UP	XT/G-8UP	8		258	\$627.00
	XT/CB-10UP	XT/G-10UP	10		347	\$882.00
	XT/CB-12UP	XT/G-12UP	12		388	\$940.00
	XT/CB-6TP	XT/G-6TP	6	*Treated #1 Southern Yellow Pine	218	\$579.00
	XT/CB-8TP	XT/G-8TP	8		258	\$640.00
	XT/CB-10TP	XT/G-10TP	10		347	\$899.00
	XT/CB-12TP	XT/G-12TP	12		388	\$960.00
	XT/CB-6AL	XT/G-6AL	6	Clear Anodized Aluminum	163	\$1,167.00
	XT/CB-8AL	XT/G-8AL	8		184	\$1,425.00
	XT/CB-10AL	XT/G-10AL	10		254	\$1,879.00
	XT/CB-12AL	XT/G-12AL	12		277	\$2,137.00
	XT/CB-6AR	XT/G-6AR	6	*Red Powder Coated Aluminum	163	\$1,167.00
	XT/CB-8AR	XT/G-8AR	8		184	\$1,425.00
	XT/CB-10AR	XT/G-10AR	10		254	\$1,879.00
	XT/CB-12AR	XT/G-12AR	12		277	\$2,137.00
	XT/CB-6PC	XT/G-6PC	6	*Cedar colored Recycled Plastic	302	\$1,093.00
	XT/CB-8PC	XT/G-8PC	8		368	\$1,306.00
	XT4/CB-10PC	XT4/G-10PC	10, 4 Frames		428	\$1,775.00
	XT/CB-6VW	XT/G-6VW	6	*Brown V-Type Thermo-plastic Coated Expanded Steel	249	\$1,326.00
XT/CB-8VW	XT/G-8VW	8	291		\$1,567.00	
XT/CB-10VW	XT/G-10VW	10	388		\$2,106.00	
XT/CB-6DW	XT/G-6DW	6	*Brown D-Type Thermo-plastic Coated Expanded Steel	217	\$1,132.00	
XT/CB-8DW	XT/G-8DW	8		249	\$1,275.00	
XT/CB-10DW	XT/G-10DW	10		333	\$1,654.00	



❄️ Snow Load Table
- see Page 29

EXTRA HEAVY DUTY TABLE -XT Series ... continued on Page 15

*See Pages 57 - 59 for optional lumber species, material color options, and the character designators to specify those options in the Model Numbers.

RJ Thomas Mfg. Co., Inc.

P.O. Box 946 • Cherokee, Iowa 51012-0946 • ORDERS Toll Free: 800-762-5002 • FAX: 712-225-5796 • 712-225-5115

EXTRA HEAVY DUTY TABLE - XT Series (Catalog Page 29) ...continued	Powder Coated Frames, Black standard *(/CB) Model No.	Hot-Dip Galvanized Frames (/G) Model No.	Length (ft.)	Material	Wt. (lbs.)	Price
2-3/8" O.D. steel pipe frames (2.375" O.D., 11 ga. wall, 2" I.D. nom. pipe specifications), 2" x 2" x 1/8" die-formed steel top and seat angles, 1-5/16" O.D. steel pipe diagonal braces, portable.	XT/CB-6HW ❄️	XT/G-6HW ❄️	6	*Brown H-Type Thermo-plastic Coated Perforated Steel	259	\$1,344.00
	XT/CB-8HW ❄️	XT/G-8HW ❄️	8		305	\$1,639.00
	XT/CB-10HW ❄️	XT/G-10HW ❄️	10		404	\$2,279.00
	XT/CB-6RW	XT/G-6RW	6	*Brown R-Type Thermo-plastic Coated Perforated Steel	218	\$1,263.00
	XT/CB-8RW	XT/G-8RW	8		270	\$1,348.00
	XT/CB-10RW	XT/G-10RW	10		349	\$1,811.00
	XT/CB-6SC/TW	XT/G-6SC/TW	6	*Brown Thermo-plastic Coated Formed Steel Channel	270	\$1,290.00
	XT/CB-8SC/TW	XT/G-8SC/TW	8		310	\$1,452.00



❄️ Snow Load Table
- see Page 29

END ACCESSIBLE TABLE - UT Series (Catalog Page 30)	Powder Coated Frames, Black standard *(/CB) Model No.	Hot-Dip Galvanized Frames (/G) Model No.	Length (ft.)	Material	Wt. (lbs.)	Price
1-5/8" O.D. steel pipe frames (1.66" O.D., 11 ga. wall, 1-1/4" I.D. nom. pipe specifications), 2" x 2" x 1/8" die-formed steel top and seat angles, 1-5/16" O.D. steel pipe diagonal braces, portable. ADA wheelchair accessible clearances provided. Top extended 2 ft. at the end with diagonal brace and channel support. Extended 2 ft. one end (/E), 2 ft. on both ends (/EE), or 1 ft. each end (/E1).	UT/CB-6UP/E	UT/G-6UP/E	Top 8, Seats 6	*Untreated #1 Southern Yellow Pine	221	\$554.00
	UT/CB-6UP/EE	UT/G-6UP/EE	Top 10, Seats 6		251	\$624.00
	UT/CB-8UP/E	UT/G-8UP/E	Top 10, Seats 8		261	\$612.00
	UT/CB-6TP/E	UT/G-6TP/E	Top 8, Seats 6	*Treated #1 Southern Yellow Pine	221	\$565.00
	UT/CB-6TP/EE	UT/G-6TP/EE	Top 10, Seats 6		251	\$638.00
	UT/CB-8TP/E	UT/G-8TP/E	Top 10, Seats 8		261	\$627.00
	UT/CB-6AL/E	UT/G-6AL/E	Top 8, Seats 6	Clear Anodized Aluminum	154	\$1,271.00
	UT/CB-6AL/EE	UT/G-6AL/EE	Top 10, Seats 6		173	\$1,461.00
	UT/CB-8AL/E	UT/G-8AL/E	Top 10, Seats 8		176	\$1,528.00
	UT/CB-6AR/E	UT/G-6AR/E	Top 8, Seats 6	*Red Powder Coated Aluminum	154	\$1,271.00
	UT/CB-6AR/EE	UT/G-6AR/EE	Top 10, Seats 6		173	\$1,461.00
	UT/CB-8AR/E	UT/G-8AR/E	Top 10, Seats 8		176	\$1,528.00
	UT/CB-6PC/E	UT/G-6PC/E	Top 8, Seats 6	*Cedar colored Recycled Plastic	320	\$1,190.00
	UT/CB-8PC/E	UT/G-8PC/E	Top 10, Seats 8		368	\$1,458.00
	UT/CB-6DW/E	UT/G-6DW/E	Top 8, Seats 6	*Brown D-Type Expanded Steel	213	\$1,151.00
	UT/CB-6RW/E	UT/G-6RW/E	Top 8, Seats 6	*Brown R-Type Perforated Steel	224	\$1,265.00
	UT/CB-6SC/TW/E	UT/G-6SC/TW/E	Top 8, Seats 6	*Brown Formed Steel Channel	264	\$1,291.00

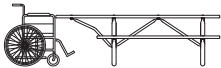

END ACCESSIBLE TABLE - XT Series (Catalog Page 30)	Powder Coated Frames, Black standard *(/CB) Model No.	Hot-Dip Galvanized Frames (/G) Model No.	Length (ft.)	Material	Wt. (lbs.)	Price
2-3/8" O.D. steel pipe frames (2.375" O.D., 11 ga. wall, 2" I.D. nom. pipe specifications), 2" x 2" x 1/8" die-formed steel top and seat angles, 1-5/16" O.D. steel pipe diagonal braces, portable. ADA wheelchair accessible clearances provided. Top extended 2 ft. at the end with diagonal brace and channel support. Extended 2 ft. one end (/E), 2 ft. on both ends (/EE), or 1 ft. each end (/E1).	XT/CB-6UP/E	XT/G-6UP/E	Top 8, Seats 6	*Untreated #1 Southern Yellow Pine	248	\$642.00
	XT/CB-6UP/EE	XT/G-6UP/EE	Top 10, Seats 6		278	\$712.00
	XT/CB-8UP/E	XT/G-8UP/E	Top 10, Seats 8		288	\$700.00
	XT/CB-6TP/E	XT/G-6TP/E	Top 8, Seats 6	*Treated #1 Southern Yellow Pine	248	\$652.00
	XT/CB-6TP/EE	XT/G-6TP/EE	Top 10, Seats 6		278	\$725.00
	XT/CB-8TP/E	XT/G-8TP/E	Top 10, Seats 8		288	\$715.00
	XT/CB-6AL/E	XT/G-6AL/E	Top 8, Seats 6	Clear Anodized Aluminum	181	\$1,358.00
	XT/CB-6AL/EE	XT/G-6AL/EE	Top 10, Seats 6		200	\$1,548.00
	XT/CB-8AL/E	XT/G-8AL/E	Top 10, Seats 8		203	\$1,615.00
	XT/CB-6AR/E	XT/G-6AR/E	Top 8, Seats 6	*Red Powder Coated Aluminum	181	\$1,358.00
	XT/CB-6AR/EE	XT/G-6AR/EE	Top 10, Seats 6		200	\$1,548.00
	XT/CB-8AR/E	XT/G-8AR/E	Top 10, Seats 8		203	\$1,615.00
	XT/CB-6PC/E	XT/G-6PC/E	Top 8, Seats 6	*Cedar colored Recycled Plastic	347	\$1,274.00
	XT/CB-8PC/E	XT/G-8PC/E	Top 10, Seats 8		395	\$1,542.00
	XT/CB-6VW/E ❄️	XT/G-6VW/E ❄️	Top 8, Seats 6	*Brown V-Type Expanded Steel	282	\$1,536.00
	XT/CB-6DW/E	XT/G-6DW/E	Top 8, Seats 6	*Brown D-Type Expanded Steel	240	\$1,237.00
	XT/CB-6HW/E ❄️	XT/G-6HW/E ❄️	Top 8, Seats 6	*Brown H-Type Perforated Steel	292	\$1,568.00
	XT/CB-6RW/E	XT/G-6RW/E	Top 8, Seats 6	*Brown R-Type Perforated Steel	251	\$1,352.00
	XT/CB-6SC/TW/E	XT/G-6SC/TW/E	Top 8, Seats 6	*Brown Formed Steel Channel	291	\$1,377.00

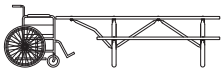

❄️ Snow Load Table
- see Page 29

*See Pages 57 – 59 for optional lumber species, material color options, and the character designators to specify those options in the Model Numbers.

RAISED TOP, END ACCESSIBLE TABLE - UTH Series (Catalog Page 30) 	Powder Coated Frames, Black standard */(CB) Model No.	Hot-Dip Galvanized Frames (G) Model No.	Length (ft.)	Material	Wt. (lbs.)	Price
	1-5/8" O.D. steel pipe frames (1.66" O.D., 11 ga. wall, 1-1/4" I.D. nom. pipe specifications), 2" x 2" x 1/8" die-formed steel top and seat angles, 1-5/16" O.D. steel pipe diagonal braces, portable. ADA wheelchair accessible clearances provided. Raised top for armrest clearance under top. Top extended 2 ft. at the end with diagonal brace and channel support. Extended 2 ft. one end (/E), 2 ft. on both ends (/EE), or 1 ft. each end (/E1).	UTH/CB-6UP/E	UTH/G-6UP/E	Top 8, Seats 6	*Untreated #1 Southern Yellow Pine	225
UTH/CB-6UP/EE		UTH/G-6UP/EE	Top 10, Seats 6	253		\$667.00
UTH/CB-8UP/E		UTH/G-8UP/E	Top 10, Seats 8	265		\$655.00
UTH/CB-6TP/E		UTH/G-6TP/E	Top 8, Seats 6	*Treated #1 Southern Yellow Pine	225	\$608.00
UTH/CB-6TP/EE		UTH/G-6TP/EE	Top 10, Seats 6		253	\$681.00
UTH/CB-8TP/E		UTH/G-8TP/E	Top 10, Seats 8		265	\$670.00
UTH/CB-6AL/E		UTH/G-6AL/E	Top 8, Seats 6	Clear Anodized Aluminum	158	\$1,314.00
UTH/CB-6AL/EE		UTH/G-6AL/EE	Top 10, Seats 6		175	\$1,504.00
UTH/CB-8AL/E		UTH/G-8AL/E	Top 10, Seats 8		180	\$1,571.00
UTH/CB-6AR/E		UTH/G-6AR/E	Top 8, Seats 6	*Red Powder Coated Aluminum	158	\$1,314.00
UTH/CB-6AR/EE		UTH/G-6AR/EE	Top 10, Seats 6		175	\$1,504.00
UTH/CB-8AR/E		UTH/G-8AR/E	Top 10, Seats 8		180	\$1,571.00
UTH/CB-6PC/E		UTH/G-6PC/E	Top 8, Seats 6	*Cedar colored Recycled Plastic	324	\$1,220.00
UTH/CB-8PC/E		UTH/G-8PC/E	Top 10, Seats 8		372	\$1,488.00
UTH/CB-6DW/E		UTH/G-6DW/E	Top 8, Seats 6	*Brown D-Type Expanded Steel	217	\$1,176.00
UTH/CB-6RW/E		UTH/G-6RW/E	Top 8, Seats 6	*Brown R-Type Perforated Steel	228	\$1,290.00
UTH/CB-6SC/TW/E		UTH/G-6SC/TW/E	Top 8, Seats 6	*Brown Formed Steel Channel	268	\$1,316.00

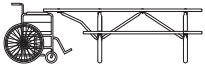

RAISED TOP, END ACCESSIBLE TABLE - XTH Series (Catalog Page 30) 	Powder Coated Frames, Black standard */(CB) Model No.	Hot-Dip Galvanized Frames (G) Model No.	Length (ft.)	Material	Wt. (lbs.)	Price
	2-3/8" O.D. steel pipe frames (2.375" O.D., 11 ga. wall, 2" I.D. nom. pipe specifications), 2" x 2" x 1/8" die-formed steel top and seat angles, 1-5/16" O.D. steel pipe diagonal braces, portable. ADA wheelchair accessible clearances provided. Raised top for armrest clearance under top. Top extended 2 ft. at the end with diagonal brace and channel support. Extended 2 ft. one end (/E), 2 ft. on both ends (/EE), or 1 ft. each end (/E1).	XTH/CB-6UP/E	XTH/G-6UP/E	Top 8, Seats 6	*Untreated #1 Southern Yellow Pine	256
XTH/CB-6UP/EE		XTH/G-6UP/EE	Top 10, Seats 6	286		\$753.00
XTH/CB-8UP/E		XTH/G-8UP/E	Top 10, Seats 8	296		\$741.00
XTH/CB-6TP/E		XTH/G-6TP/E	Top 8, Seats 6	*Treated #1 Southern Yellow Pine	256	\$693.00
XTH/CB-6TP/EE		XTH/G-6TP/EE	Top 10, Seats 6		286	\$766.00
XTH/CB-8TP/E		XTH/G-8TP/E	Top 10, Seats 8		296	\$756.00
XTH/CB-6AL/E		XTH/G-6AL/E	Top 8, Seats 6	Clear Anodized Aluminum	189	\$1,399.00
XTH/CB-6AL/EE		XTH/G-6AL/EE	Top 10, Seats 6		208	\$1,589.00
XTH/CB-8AL/E		XTH/G-8AL/E	Top 10, Seats 8		211	\$1,656.00
XTH/CB-6AR/E		XTH/G-6AR/E	Top 8, Seats 6	*Red Powder Coated Aluminum	189	\$1,399.00
XTH/CB-6AR/EE		XTH/G-6AR/EE	Top 10, Seats 6		208	\$1,589.00
XTH/CB-8AR/E		XTH/G-8AR/E	Top 10, Seats 8		211	\$1,656.00
XTH/CB-6PC/E		XTH/G-6PC/E	Top 8, Seats 6	*Cedar colored Recycled Plastic	355	\$1,319.00
XTH/CB-8PC/E		XTH/G-8PC/E	Top 10, Seats 8		403	\$1,587.00
XTH/CB-6VW/E ❄️		XTH/G-6VW/E ❄️	Top 8, Seats 6	*Brown V-Type Expanded Steel	290	\$1,577.00
XTH/CB-6DW/E		XTH/G-6DW/E	Top 8, Seats 6	*Brown D-Type Expanded Steel	248	\$1,278.00
XTH/CB-6HW/E ❄️		XTH/G-6HW/E ❄️	Top 8, Seats 6	*Brown H-Type Perforated Steel	300	\$1,609.00
XTH/CB-6RW/E		XTH/G-6RW/E	Top 8, Seats 6	*Brown R-Type Perforated Steel	259	\$1,393.00
XTH/CB-6SC/TW/E	XTH/G-6SC/TW/E	Top 8, Seats 6	*Brown Formed Steel Channel	299	\$1,418.00	

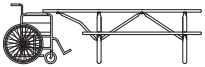

❄️ Snow Load Table - see Page 29

SIDE ACCESSIBLE TABLE - UT Series (Catalog Page 30) 	Powder Coated Frames, Black standard */(CB) Model No.	Hot-Dip Galvanized Frames (G) Model No.	Length (ft.)	Material	Wt. (lbs.)	Price
	1-5/8" O.D. steel pipe frames (1.66" O.D., 11 ga. wall, 1-1/4" I.D. nom. pipe specifications), 2" x 2" x 1/8" die-formed steel top and seat angles, 1-5/16" O.D. steel pipe diagonal braces, portable. ADA wheelchair accessible clearances provided on the side of the table by openings in the seating.	UT/CB-6UP/SA	UT/G-6UP/SA	6	*Untreated #1 Southern Yellow Pine	172
UT/CB-8UP/SA		UT/G-8UP/SA	8	197		\$508.00
UT/CB-10UP/SA		UT/G-10UP/SA	10	303		\$776.00
UT/CB-12UP/SA		UT/G-12UP/SA	12	328	\$810.00	
UT/CB-6TP/SA		UT/G-6TP/SA	6	*Treated #1 Southern Yellow Pine	172	\$511.00
UT/CB-8TP/SA		UT/G-8TP/SA	8		197	\$559.00
UT/CB-10TP/SA		UT/G-10TP/SA	10		303	\$791.00
UT/CB-12TP/SA		UT/G-12TP/SA	12	328	\$827.00	
UT/CB-6AL/SA		UT/G-6AL/SA	6	Clear Anodized Aluminum	144	\$1,059.00
UT/CB-8AL/SA		UT/G-8AL/SA	8		161	\$1,290.00
UT/CB-10AL/SA		UT/G-10AL/SA	10		217	\$1,665.00
UT/CB-12AL/SA		UT/G-12AL/SA	12	235	\$1,897.00	
UT/CB-6AR/SA		UT/G-6AR/SA	6	*Red Powder Coated Aluminum	144	\$1,059.00
UT/CB-8AR/SA		UT/G-8AR/SA	8		161	\$1,290.00
UT/CB-10AR/SA		UT/G-10AR/SA	10		217	\$1,665.00
UT/CB-12AR/SA		UT/G-12AR/SA	12	235	\$1,897.00	
UT/CB-6PC/SA		UT/G-6PC/SA	6	*Cedar colored Recycled Plastic	265	\$1,000.00
UT/CB-8PC/SA		UT/G-8PC/SA	8		318	\$1,172.00

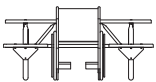

*See Pages 57 - 59 for optional lumber species, material color options, and the character designators to specify those options in the Model Numbers.

SIDE ACCESSIBLE TABLE -XT Series (Catalog Page 30) 	Powder Coated Frames, Black standard *(/CB) Model No.	Hot-Dip Galvanized Frames (/G) Model No.	Length (ft.)	Material	Wt. (lbs.)	Price
	2-3/8" O.D. steel pipe frames (2.375" O.D., 11 ga. wall, 2" I.D. nom. pipe specifications), 2" x 2" x 1/8" die-formed steel top and seat angles, 1-5/16" O.D. steel pipe diagonal braces, portable. ADA wheelchair accessible clearances provided on the side of the table by openings in the seating.	XT/CB-6UP/SA	XT/G-6UP/SA	6	*Untreated #1 Southern Yellow Pine	199
XT/CB-8UP/SA		XT/G-8UP/SA	8	224		\$635.00
XT/CB-10UP/SA		XT/G-10UP/SA	10	344		\$891.00
XT/CB-12UP/SA		XT/G-12UP/SA	12	*Treated #1 Southern Yellow Pine	369	\$925.00
XT/CB-6TP/SA		XT/G-6TP/SA	6		199	\$597.00
XT/CB-8TP/SA		XT/G-8TP/SA	8		224	\$645.00
XT/CB-10TP/SA		XT/G-10TP/SA	10		344	\$906.00
XT/CB-12TP/SA		XT/G-12TP/SA	12	Clear Anodized Aluminum	369	\$942.00
XT/CB-6AL/SA		XT/G-6AL/SA	6		171	\$1,146.00
XT/CB-8AL/SA		XT/G-8AL/SA	8		188	\$1,377.00
XT/CB-10AL/SA		XT/G-10AL/SA	10	*Red Powder Coated Aluminum	258	\$1,583.00
XT/CB-12AL/SA		XT/G-12AL/SA	12		276	\$1,815.00
XT/CB-6AR/SA		XT/G-6AR/SA	6		171	\$1,146.00
XT/CB-8AR/SA		XT/G-8AR/SA	8	*Cedar colored Recycled Plastic	188	\$1,377.00
XT/CB-10AR/SA		XT/G-10AR/SA	10		258	\$1,583.00
XT/CB-12AR/SA		XT/G-12AR/SA	12		276	\$1,815.00
XT/CB-6PC/SA		XT/G-6PC/SA	6	10, 4 Frames	292	\$1,084.00
XT/CB-8PC/SA		XT/G-8PC/SA	8		345	\$1,256.00
XT4/CB-10PC/SA		XT4/G-10PC/SA	10, 4 Frames		485	\$1,819.00

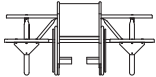

KID'S TABLE -UTK Series -Rectangular Table (Catalog Page 31)	Powder Coated Frames, Black standard *(/CB) Model No.	Hot-Dip Galvanized Frames (/G) Model No.	Length (ft.)	Material	Wt. (lbs.)	Price
	1-5/8" O.D. steel pipe frames (1.66" O.D., 11 ga. wall, 1-1/4" I.D. nom. pipe specifications), 2" x 2" x 1/8" die-formed steel top and seat angles, 1-5/16" O.D. steel pipe diagonal braces, portable. Seats 12" high, Top 22" high.	UTK/CB-4UP	UTK/G-4UP	4	*Untreated #1 Southern Yellow Pine	130
UTK/CB-6UP		UTK/G-6UP	6	169		\$410.00
UTK/CB-8UP		UTK/G-8UP	8	209		\$469.00
UTK/CB-4TP		UTK/G-4TP	4	*Treated #1 Southern Yellow Pine	130	\$357.00
UTK/CB-6TP		UTK/G-6TP	6		169	\$421.00
UTK/CB-8TP		UTK/G-8TP	8		209	\$483.00
UTK/CB-4AL		UTK/G-4AL	4	Clear Anodized Aluminum	92	\$751.00
UTK/CB-6AL		UTK/G-6AL	6		113	\$1,008.00
UTK/CB-8AL		UTK/G-8AL	8		134	\$1,266.00
UTK/CB-4AR		UTK/G-4AR	4	*Red Powder Coated Aluminum	92	\$751.00
UTK/CB-6AR		UTK/G-6AR	6		113	\$1,008.00
UTK/CB-8AR		UTK/G-8AR	8		134	\$1,266.00
UTK/CB-4PC		UTK/G-4PC	4	*Cedar colored Recycled Plastic	160	\$629.00
UTK/CB-6PC		UTK/G-6PC	6		253	\$934.00
UTK/CB-8PC		UTK/G-8PC	8		319	\$1,147.00
UTK/CB-6DW		UTK/G-6DW	6	*Brown D-Type Thermo-plastic Coated Expanded Steel	166	\$974.00
UTK/CB-8DW		UTK/G-8DW	8		198	\$1,117.00
UTK/CB-6RW		UTK/G-6RW	6	*Brown R-Type Thermo-plastic Coated Perforated Steel	167	\$1,105.00
UTK/CB-8RW		UTK/G-8RW	8		219	\$1,190.00
UTK/CB-6SC/TW		UTK/G-6SC/TW	6	*Brown Thermo-plastic Coated Formed Steel Channel	219	\$1,131.00
UTK/CB-8SC/TW	UTK/G-8SC/TW	8	259		\$1,294.00	



KID'S TABLE -SQTK Series -Square Table (Catalog Page 31)	Powder Coated Frames, Black standard *(/CB) Model No.	Hot-Dip Galvanized Frames (/G) Model No.	Material	Wt. (lbs.)	Price
	48" Square Top, 1-1/2" O.D. x 1/8" wall structural steel pipe frames, 1-3/4" x 1-3/4" x 1/8" die-formed steel top and seat angles, 1-5/16" O.D. steel pipe cross braces, portable.	SQTK/CB-4UP	SQTK/G-4UP	*Untreated #1 Southern Yellow Pine	198
SQTK/CB-4TP		SQTK/G-4TP	*Treated #1 Southern Yellow Pine	198	\$607.00
SQTK/CB-4AL		SQTK/G-4AL	Clear Anodized Aluminum	126	\$1,262.00
SQTK/CB-4AR		SQTK/G-4AR	*Red Powder Coated Aluminum	126	\$1,262.00
SQTK/CB-4PC		SQTK/G-4PC	*Cedar colored Recycled Plastic	253	\$1,046.00
SQTK/CB-4VW		SQTK/G-4VW	*Brown V-Type Expanded Steel	197	\$1,102.00
SQTK/CB-4HW		SQTK/G-4HW	*Brown H-Type Perforated Steel	208	\$1,212.00

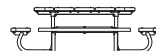

*See Pages 57 – 59 for optional lumber species, material color options, and the character designators to specify those options in the Model Numbers.

RJ Thomas Mfg. Co., Inc.

P.O. Box 946 • Cherokee, Iowa 51012-0946 • ORDERS Toll Free: 800-762-5002 • FAX: 712-225-5796 • 712-225-5115

KID'S TABLE -T104K Series -Round Table (Catalog Page 31) 48" diameter Round Top, (4) Curved Seats. 1-1/2" O.D. x 1/8" wall structural steel pipe frames, 1-3/4" x 1-3/4" x 1/8" die-formed steel top and seat angles, 1-5/16" O.D. steel pipe cross braces, portable.	Powder Coated Frames, Black standard */(CB) Model No.	Hot-Dip Galvanized Frames (/G) Model No.	Seat Style	Material	Wt. (lbs.)	Price
	T104K/CB-4PC	T104K/G-4PC	4 Curved	*Cedar colored Recycled Plastic	262	\$1,409.00
	T104K/CB-4DW	T104K/G-4DW		*Brown D-Type Expanded Steel	246	\$1,273.00
	T104K/CB-4RW	T104K/G-4RW		*Brown R-Type Perforated Steel	254	\$1,404.00



UNIVERSAL ACCESS TABLE -WXT Series (Catalog Page 32) Patented wheelchair accessible table design with access at both ends and full length seats. 2-3/8" O.D. steel pipe frames, portable.	Powder Coated Frames, Black standard */(CB) Model No.	Hot-Dip Galvanized Frames (/G) Model No.	Length (ft.)	Material	Wt. (lbs.)	Price
	WXT/CB-6UP	WXT/G-6UP	6	*Untreated #1 Southern Yellow Pine	218	\$682.00
WXT/CB-8UP	WXT/G-8UP	8	258		\$742.00	
WXT/CB-10UP	WXT/G-10UP	10	347		\$996.00	
WXT/CB-12UP	WXT/G-12UP	12	*Treated #1 Southern Yellow Pine	388	\$1,055.00	
WXT/CB-6TP	WXT/G-6TP	6		218	\$694.00	
WXT/CB-8TP	WXT/G-8TP	8		258	\$755.00	
WXT/CB-10TP	WXT/G-10TP	10	Clear Anodized Aluminum	347	\$1,013.00	
WXT/CB-12TP	WXT/G-12TP	12		388	\$1,074.00	
WXT/CB-6AL	WXT/G-6AL	6		163	\$1,282.00	
WXT/CB-8AL	WXT/G-8AL	8	*Red Powder Coated Aluminum	184	\$1,540.00	
WXT/CB-10AL	WXT/G-10AL	10		254	\$1,994.00	
WXT/CB-12AL	WXT/G-12AL	12		277	\$2,252.00	
WXT/CB-6AR	WXT/G-6AR	6	*Cedar colored Recycled Plastic	163	\$1,282.00	
WXT/CB-8AR	WXT/G-8AR	8		184	\$1,540.00	
WXT/CB-10AR	WXT/G-10AR	10		254	\$1,994.00	
WXT/CB-12AR	WXT/G-12AR	12	*Brown V-Type Thermo-plastic Coated Expanded Steel	277	\$2,252.00	
WXT/CB-6PC	WXT/G-6PC	6		302	\$1,205.00	
WXT/CB-8PC	WXT/G-8PC	8		368	\$1,423.00	
WXT/CB-6VW ❄️	WXT/G-6VW ❄️	6	*Brown D-Type Thermo-plastic Coated Expanded Steel	249	\$1,442.00	
WXT/CB-8VW ❄️	WXT/G-8VW ❄️	8		291	\$1,683.00	
WXT/CB-10VW	WXT/G-10VW	10		388	\$2,151.00	
WXT/CB-6DW	WXT/G-6DW	6	*Brown H-Type Thermo-plastic Coated Perforated Steel	217	\$1,247.00	
WXT/CB-8DW	WXT/G-8DW	8		249	\$1,390.00	
WXT/CB-10DW	WXT/G-10DW	10		333	\$1,768.00	
WXT/CB-6HW ❄️	WXT/G-6HW ❄️	6	*Brown R-Type Thermo-plastic Coated Perforated Steel	259	\$1,468.00	
WXT/CB-8HW ❄️	WXT/G-8HW ❄️	8		305	\$1,757.00	
WXT/CB-10HW	WXT/G-10HW	10		404	\$2,393.00	
WXT/CB-6RW	WXT/G-6RW	6	*Brown Thermo-plastic Coated Formed Steel Channel	218	\$1,378.00	
WXT/CB-8RW	WXT/G-8RW	8		270	\$1,463.00	
WXT/CB-10RW	WXT/G-10RW	10		349	\$1,925.00	
WXT/CB-6SC/TW	WXT/G-6SC/TW	6		270	\$1,406.00	
WXT/CB-8SC/TW	WXT/G-8SC/TW	8		310	\$1,569.00	

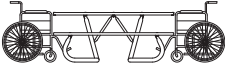

❄️ Snow Load Table - see Page 29

UNIVERSAL ACCESS TABLE with Raised Top -WXTH Series (Catalog Page 32) Patented wheelchair accessible table design with access at both ends, full length seats, and raised top. 2-3/8" O.D. steel pipe frames, portable.	Powder Coated Frames, Black standard */(CB) Model No.	Hot-Dip Galvanized Frames (/G) Model No.	Length (ft.)	Material	Wt. (lbs.)	Price
	WXTH/CB-6UP	WXTH/G-6UP	6	*Untreated #1 Southern Yellow Pine	236	\$751.00
WXTH/CB-8UP	WXTH/G-8UP	8	276		\$811.00	
WXTH/CB-10UP	WXTH/G-10UP	10	358		\$1,086.00	
WXTH/CB-12UP	WXTH/G-12UP	12	*Treated #1 Southern Yellow Pine	399	\$1,145.00	
WXTH/CB-6TP	WXTH/G-6TP	6		236	\$763.00	
WXTH/CB-8TP	WXTH/G-8TP	8		276	\$824.00	
WXTH/CB-10TP	WXTH/G-10TP	10	Clear Anodized Aluminum	358	\$1,103.00	
WXTH/CB-12TP	WXTH/G-12TP	12		399	\$1,164.00	
WXTH/CB-6AL	WXTH/G-6AL	6		181	\$1,351.00	
WXTH/CB-8AL	WXTH/G-8AL	8	*Red Powder Coated Aluminum	202	\$1,609.00	
WXTH/CB-10AL	WXTH/G-10AL	10		265	\$2,084.00	
WXTH/CB-12AL	WXTH/G-12AL	12		288	\$2,342.00	
WXTH/CB-6AR	WXTH/G-6AR	6		181	\$1,351.00	
WXTH/CB-8AR	WXTH/G-8AR	8		202	\$1,609.00	
WXTH/CB-10AR	WXTH/G-10AR	10		265	\$2,084.00	
WXTH/CB-12AR	WXTH/G-12AR	12		288	\$2,342.00	





UNIVERSAL ACCESS TABLE with Raised Top -WXTH Series ... continued on Page 19

*See Pages 57 - 59 for optional lumber species, material color options, and the character designators to specify those options in the Model Numbers.

RJ Thomas Mfg. Co., Inc.



P.O. Box 946 • Cherokee, Iowa 51012-0946 • ORDERS Toll Free: 800-762-5002 • FAX: 712-225-5796 • 712-225-5115

UNIVERSAL ACCESS TABLE with Raised Top - WXTH Series (Catalog Page 32) ...continued		Powder Coated Frames, Black standard *(/CB) Model No.	Hot-Dip Galvanized Frames (/G) Model No.	Length (ft.)	Material	Wt. (lbs.)	Price
Patented wheelchair accessible table design with access at both ends, full length seats, and raised top. 2-3/8" O.D. steel pipe frames, portable.		WXTH/CB-6PC	WXTH/G-6PC	6	*Cedar colored	320	\$1,311.00
		WXTH/CB-8PC	WXTH/G-8PC	8	Recycled Plastic	386	\$1,529.00
		WXTH/CB-6VW ❄️	WXTH/G-6VW ❄️	6	*Brown V-Type	267	\$1,511.00
		WXTH/CB-8VW ❄️	WXTH/G-8VW ❄️	8	Thermo-plastic Coated	309	\$1,752.00
		WXTH/CB-10VW	WXTH/G-10VW	10	Expanded Steel	399	\$2,241.00
		WXTH/CB-6DW	WXTH/G-6DW	6	*Brown D-Type	235	\$1,316.00
		WXTH/CB-8DW	WXTH/G-8DW	8	Thermo-plastic Coated	267	\$1,459.00
		WXTH/CB-10DW	WXTH/G-10DW	10	Expanded Steel	344	\$1,858.00
		WXTH/CB-6HW ❄️	WXTH/G-6HW ❄️	6	*Brown H-Type	277	\$1,537.00
		WXTH/CB-8HW ❄️	WXTH/G-8HW ❄️	8	Thermo-plastic Coated	323	\$1,826.00
		WXTH/CB-10HW	WXTH/G-10HW	10	Perforated Steel	415	\$2,483.00
		WXTH/CB-6RW	WXTH/G-6RW	6	*Brown R-Type	236	\$1,447.00
		WXTH/CB-8RW	WXTH/G-8RW	8	Thermo-plastic Coated	288	\$1,532.00
		WXTH/CB-10RW	WXTH/G-10RW	10	Perforated Steel	360	\$2,015.00
		WXTH/CB-6SC/TW	WXTH/G-6SC/TW	6	*Brown Thermo-plastic Coated	288	\$1,475.00
		WXTH/CB-8SC/TW	WXTH/G-8SC/TW	8	Formed Steel Channel	328	\$1,638.00

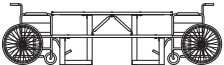
❄️ Snow Load Table
- see Page 29

UNIVERSAL ACCESS TABLE with Square Frame - WPTS Series (Catalog Page 33)		Powder Coated Frames, Black standard *(/CB) Model No.	Hot-Dip Galvanized Frames (/G) Model No.	Length (ft.)	Material	Wt. (lbs.)	Price
Patented wheelchair accessible table design with access at both ends, full length seats. 3" x 6" nom. x 1/8" wall rectangular steel tube top and seat supports, connected by 2-1/2" nom. x 1/8" wall square steel tube, portable.		WPTS/CB-6UP	WPTS/G-6UP	6	*Untreated	264	\$847.00
		WPTS/CB-8UP	WPTS/G-8UP	8	#1 Southern Yellow Pine	304	\$906.00
		WPTS/CB-6TP	WPTS/G-6TP	6	*Treated	264	\$858.00
		WPTS/CB-8TP	WPTS/G-8TP	8	#1 Southern Yellow Pine	304	\$920.00
		WPTS/CB-6AL	WPTS/G-6AL	6	Clear Anodized	209	\$1,445.00
		WPTS/CB-8AL	WPTS/G-8AL	8	Aluminum	230	\$1,703.00
		WPTS/CB-6AR	WPTS/G-6AR	6	*Red Powder Coated	209	\$1,445.00
		WPTS/CB-8AR	WPTS/G-8AR	8	Aluminum	230	\$1,703.00
		WPTS/CB-6PC	WPTS/G-6PC	6	*Cedar colored	348	\$1,371.00
		WPTS/CB-8PC	WPTS/G-8PC	8	Recycled Plastic	414	\$1,584.00
		WPTS/CB-6VW ❄️	WPTS/G-6VW ❄️	6	*Brown V-Type Thermo-plastic	295	\$1,605.00
		WPTS/CB-8VW ❄️	WPTS/G-8VW ❄️	8	Coated Expanded Steel	337	\$1,847.00
		WPTS/CB-6DW	WPTS/G-6DW	6	*Brown D-Type Thermo-plastic	263	\$1,411.00
		WPTS/CB-8DW	WPTS/G-8DW	8	Coated Expanded Steel	295	\$1,554.00
		WPTS/CB-6HW ❄️	WPTS/G-6HW ❄️	6	*Brown H-Type Thermo-plastic	305	\$1,632.00
		WPTS/CB-8HW ❄️	WPTS/G-8HW ❄️	8	Coated Perforated Steel	351	\$1,922.00
		WPTS/CB-6RW	WPTS/G-6RW	6	*Brown R-Type Thermo-plastic	264	\$1,542.00
		WPTS/CB-8RW	WPTS/G-8RW	8	Coated Perforated Steel	316	\$1,626.00
		WPTS/CB-6SC/TW	WPTS/G-6SC/TW	6	*Brown Thermo-plastic Coated	316	\$1,568.00
		WPTS/CB-8SC/TW	WPTS/G-8SC/TW	8	Formed Steel Channel	356	\$1,731.00

❄️ Snow Load Table
- see Page 29

CUSTOM IDENTITY TABLE - T720 Series (Catalog Page 33)		Powder Coated Frames, Black standard *(/CB) Model No.	Hot-Dip Galvanized Frames (/G) Model No.	Length (ft.)	Material	Wt. (lbs.)	Price
<div style="border: 1px solid red; border-radius: 50%; padding: 2px; display: inline-block; color: red; font-weight: bold;">New!</div> 2-1/2" x 2-1/2" nom. x 1/8" wall square steel tube base and seat supports, 10 ga. die-formed vertical support panel and top and seat mounting angles, 1-5/16" O.D. steel pipe diagonal braces, portable.		T720/CB-6UP	T720/G-6UP	6	*Untreated	240	\$742.00
		T720/CB-8UP	T720/G-8UP	8	#1 Southern Yellow Pine	279	\$812.00
		T720/CB-6TP	T720/G-6TP	6	*Treated	240	\$767.00
		T720/CB-8TP	T720/G-8TP	8	#1 Southern Yellow Pine	279	\$827.00
		T720/CB-6AL	T720/G-6AL	6	Clear Anodized	185	\$1,335.00
		T720/CB-8AL	T720/G-8AL	8	Aluminum	205	\$1,593.00
		T720/CB-6AR	T720/G-6AR	6	*Red Powder Coated	185	\$1,335.00
		T720/CB-8AR	T720/G-8AR	8	Aluminum	205	\$1,593.00
		T720/CB-6PC	T720/G-6PC	6	*Cedar colored	324	\$1,353.00
		T720/CB-8PC	T720/G-8PC	8	Recycled Plastic	389	\$1,594.00
		T720/CB-6DW	T720/G-6DW	6	*Brown D-Type Thermo-plastic	239	\$1,337.00
		T720/CB-8DW	T720/G-8DW	8	Coated Expanded Steel	270	\$1,485.00
		T720/CB-6RW	T720/G-6RW	6	*Brown R-Type Thermo-plastic	240	\$1,474.00
		T720/CB-8RW	T720/G-8RW	8	Coated Perforated Steel	291	\$1,561.00
		T720/CB-6SC/TW	T720/G-6SC/TW	6	*Brown Thermo-plastic Coated	292	\$1,460.00
		T720/CB-8SC/TW	T720/G-8SC/TW	8	Formed Steel Channel	331	\$1,622.00



CUSTOM IDENTITY TABLE -T720 Series ... continued on Page 20

*See Pages 57 - 59 for optional lumber species, material color options, and the character designators to specify those options in the Model Numbers.

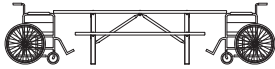
CUSTOM IDENTITY ACCESSIBLE TABLE - T720 Series (Catalog Page 33)  2-1/2" x 2-1/2" nom. x 1/8" wall square steel tube base and seat supports, 10 ga. die-formed vertical support panel and top and seat mounting angles, 1-5/16" O.D. steel pipe diagonal braces, portable. ADA wheelchair accessible clearances provided. Top extended 1 ft. at each end (E1).	Powder Coated Frames, Black standard *(/CB) Model No.	Hot-Dip Galvanized Frames (/G) Model No.	Length (ft.)	Material	Wt. (lbs.)	Price
	T720/CB-6UP/E1	T720/G-6UP/E1	Top 8, Seats 6	*Untreated #1 Southern Yellow Pine	263	\$784.00
	T720/CB-6TP/E1	T720/G-6TP/E1	Top 8, Seats 6	*Treated #1 Southern Yellow Pine	263	\$803.00
	T720/CB-6AL/E1	T720/G-6AL/E1	Top 8, Seats 6	Clear Anodized Aluminum	196	\$1,490.00
	T720/CB-6AR/E1	T720/G-6AR/E1	Top 8, Seats 6	*Red Powder Coated Aluminum	196	\$1,490.00
	T720/CB-6PC/E1	T720/G-6PC/E1	Top 8, Seats 6	*Cedar colored Recycled Plastic	369	\$1,427.00
	T720/CB-6DW/E1	T720/G-6DW/E1	Top 8, Seats 6	*Brown D-Type Thermo-plastic Coated Expanded Steel	255	\$1,405.00
	T720/CB-6RW/E1	T720/G-6RW/E1	Top 8, Seats 6	*Brown R-Type Thermo-plastic Coated Perforated Steel	266	\$1,527.00
	T720/CB-6SC/TW/E1	T720/G-6SC/TW/E1	Top 8, Seats 6	*Brown Thermo-plastic Coated Formed Steel Channel	306	\$1,527.00







	A-FRAME TABLE - AFT Series: Traditional All Lumber or All Recycled Plastic (Catalog Page 34) All components and bracing are of Lumber or 100% Recycled Plastic. 4" x 6" leg posts, 2" x 4" and 2" x 6" connecting and support braces, 2" x 10" top and seat planks, portable. 8 Ft. tables provide ADA compliant wheelchair access at both ends.
---	--

AFT Series - All Lumber					AFT Series - All Recycled Plastic				
Model No.	Length (ft.)	Material	Wt. (lbs.)	Price	Model No.	Length (ft.)	Material	Wt. (lbs.)	Price
AFT-6TP	6	Treated Pine	210	\$436.00	AFT/W-6PC	6	▲ Recycled Plastic: Brown Frames and Cedar colored Top/Seat Planks	334	\$1,458.00
AFT-8TP 	8	Frames and Seat Planks	280	\$486.00	AFT/W-8PC 	8		386	\$1,670.00

▲ Frames also available in Black Recycled Plastic: change /W in the model numbers to /B. For other Recycled Plastic colors for the Seat and Top Planks see Page 58.

	A-FRAME TABLE - AT Series with Steel Support Components (Catalog Page 35) Top and seat mounting angles, cross supports, and diagonal braces of pre-galvanized steel. 4" x 6" leg posts, 2" x 10" top and seat planks, portable. /E1 tables and WAT-8 table are wheelchair accessible at both ends.
---	--

AT Series - Lumber Frames and Planks					AT Series - Recycled Plastic Frames and Planks				
Model No.	Length (ft.)	Material	Wt. (lbs.)	Price	Model No.	Length (ft.)	Material	Wt. (lbs.)	Price
AT-6TP	6	Treated #1 Southern Yellow Pine Frames and 2" x 10" Planks	213	\$455.00	AT/W-6PC	6	*Recycled Plastic: Brown Frames and 2" x 10" Cedar colored Planks	328	\$1,043.00
AT-6TP/E1 	Top 8, Seats 6		237	\$503.00	AT/W-6PC/E1 	Top 8, Seats 6		368	\$1,170.00
AT-8TP	8		251	\$514.00	AT/W-8PC	8		394	\$1,272.00
AT-12TP	12, 3 Frames		378	\$777.00	WAT/W-8PC  	8		430	\$1,620.00

 Snow Load Table - see page 29

"CATERPILLAR" TABLE - T600 Series (Catalog Page 36) 2-3/8" O.D. steel pipe frames (2.375" O.D., 11 ga. wall, 2" I.D. nom. pipe specifications), 10 ga. welded steel plate seat support brackets, 1-5/16" O.D. steel pipe diagonal braces, surface mount concrete anchors included . All tables are ADA accessible at both ends.	Powder Coated Frames, Black standard *(/CB) Model No.	Hot-Dip Galvanized Frames (/G) Model No.	No. of Seats	Length (ft.)	Material	Wt. (lbs.)	Price
	T602/CB-6UP	T602/G-6UP	2 full length	6	*Untreated #1 Southern Yellow Pine	224	\$508.00
	T602/CB-8UP	T602/G-8UP	2 full length	8		263	\$567.00
	T603/CB-8UP	T603/G-8UP	1 full length, 2 short	8		255	\$567.00
	T604/CB-8UP	T604/G-8UP	4 short	8		247	\$567.00
	T602/CB-10UP	T602/G-10UP	2 full length	10		357	\$789.00
	T604/CB-10UP	T604/G-10UP	1 full length, 3 short	10		353	\$789.00
	T606/CB-10UP	T606/G-10UP	6 short	10	349	\$789.00	
	T602/CB-6TP	T602/G-6TP	2 full length	6	*Treated #1 Southern Yellow Pine	224	\$519.00
	T602/CB-8TP	T602/G-8TP	2 full length	8		263	\$581.00
	T603/CB-8TP	T603/G-8TP	1 full length, 2 short	8		255	\$581.00
	T604/CB-8TP	T604/G-8TP	4 short	8		247	\$581.00
	T602/CB-10TP	T602/G-10TP	2 full length	10		357	\$806.00
	T604/CB-10TP	T604/G-10TP	1 full length, 3 short	10		353	\$806.00
	T606/CB-10TP	T606/G-10TP	6 short	10	349	\$806.00	
	T602/CB-6AL	T602/G-6AL	2 full length	6	Clear Anodized Aluminum	169	\$961.00
	T602/CB-8AL	T602/G-8AL	2 full length	8		188	\$1,171.00
T603/CB-8AL	T603/G-8AL	1 full length, 2 short	8	184		\$1,171.00	
T604/CB-8AL	T604/G-8AL	4 short	8	188		\$1,171.00	
T602/CB-10AL	T602/G-10AL	2 full length	10	264		\$1,546.00	
T604/CB-10AL	T604/G-10AL	1 full length, 3 short	10	262		\$1,546.00	
T606/CB-10AL	T606/G-10AL	6 short	10	260	\$1,546.00		

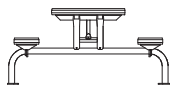

"CATERPILLAR" TABLE - T600 Series ... continued on Page 21

*See Pages 57 - 59 for optional lumber species, material color options, and the character designators to specify those options in the Model Numbers.

RJ Thomas Mfg. Co., Inc.

P.O. Box 946 • Cherokee, Iowa 51012-0946 • ORDERS Toll Free: 800-762-5002 • FAX: 712-225-5796 • 712-225-5115

"CATERPILLAR" TABLE - T600 Series (Catalog Page 36) ...continued 2-3/8" O.D. steel pipe frames (2.375" O.D., 11 ga. wall, 2" I.D. nom. pipe specifications), 10 ga. welded steel plate seat support brackets, 1-5/16" O.D. steel pipe diagonal braces, surface mount - concrete anchors included . All tables are ADA accessible at both ends.	Powder Coated Frames, Black standard *(/CB) Model No.	Hot-Dip Galvanized Frames (/G) Model No.	No. of Seats	Length (ft.)	Material	Wt. (lbs.)	Price
		T602/CB-6AR	T602/G-6AR	2 full length	6	*Red Powder Coated Aluminum	169
	T602/CB-8AR	T602/G-8AR	2 full length	8	188		\$1,171.00
	T603/CB-8AR	T603/G-8AR	1 full length, 2 short	8	184		\$1,171.00
	T604/CB-8AR	T604/G-8AR	4 short	8	188		\$1,171.00
	T602/CB-10AR	T602/G-10AR	2 full length	10	264		\$1,546.00
	T604/CB-10AR	T604/G-10AR	1 full length, 3 short	10	262		\$1,546.00
	T606/CB-10AR	T606/G-10AR	6 short	10	260	\$1,546.00	
	T602/CB-6DW	T602/G-6DW	2 full length	6	*Brown D-Type Expanded Steel	207	\$1,072.00
	T602/CB-8DW	T602/G-8DW	2 full length	8		228	\$1,216.00
	T603/CB-8DW	T603/G-8DW	1 full length, 2 short	8		225	\$1,260.00
	T604/CB-8DW	T604/G-8DW	4 short	8		222	\$1,281.00
	T602/CB-10DW	T602/G-10DW	2 full length	10		323	\$1,561.00
	T604/CB-10DW	T604/G-10DW	1 full length, 3 short	10		327	\$1,696.00
	T606/CB-10DW	T606/G-10DW	6 short	10	330	\$1,832.00	
	T602/CB-6RW	T602/G-6RW	2 full length	6	*Brown R-Type Perforated Steel	223	\$1,204.00
	T602/CB-8RW	T602/G-8RW	2 full length	8		247	\$1,289.00
	T603/CB-8RW	T603/G-8RW	1 full length, 2 short	8		241	\$1,333.00
	T604/CB-8RW	T604/G-8RW	4 short	8		234	\$1,375.00
	T602/CB-10RW	T602/G-10RW	2 full length	10		338	\$1,718.00
	T604/CB-10RW	T604/G-10RW	1 full length, 3 short	10		337	\$1,818.00
	T606/CB-10RW	T606/G-10RW	6 short	10	336	\$1,916.00	
	T602/CB-6SC/TW	T602/G-6SC/TW	2 full length	6	*Brown Formed Steel Channel	276	\$1,356.00
	T602/CB-8SC/TW	T602/G-8SC/TW	2 full length	8		314	\$1,519.00

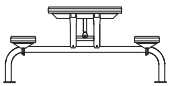

 LIGHT DUTY TABLE - BT Series (Catalog Page 36) Bolt-together pre-galvanized frames, 1-5/16" O.D. steel pipe diagonal braces, portable. BTUG Series: 1-5/8" O.D. x 12 Ga. steel tube frames BTXG Series: 2-3/8" O.D. x 12 Ga. steel tube frames										
BTUG Series - Pregalvanized Frames					BTXG Series - Pregalvanized Frames					
Model No.	Length (ft.)	Material	Wt. (lbs.)	Price	Model No.	Length (ft.)	Material	Wt. (lbs.)	Price	
BTUG-4UP	4	*Untreated	137	\$417.00	BTXG-6UP	6	*Untreated #1	195	\$521.00	
BTUG-6UP	6	#1 Southern Yellow Pine	175	\$474.00	BTXG-8UP	8	Southern Yellow Pine	233	\$579.00	
BTUG-8UP	8		213	\$533.00	BTXG-6TP	6	*Treated #1	195	\$528.00	
BTUG-4TP	4	*Treated	137	\$422.00	BTXG-8TP	8	Southern Yellow Pine	233	\$589.00	
BTUG-6TP	6	#1 Southern Yellow Pine	175	\$482.00	BTXG-6AL	6	Clear Anodized Aluminum	140	\$1,118.00	
BTUG-8TP	8		213	\$543.00	BTXG-8AL	8		159	\$1,376.00	
BTUG-4AL	4	Clear Anodized Aluminum	100	\$815.00	BTXG-6AR	6	*Red Powder Coated Aluminum	140	\$1,118.00	
BTUG-6AL	6		120	\$1,072.00	BTXG-8AR	8		159	\$1,376.00	
BTUG-8AL	8		139	\$1,330.00						
BTUG-4AR	4	*Red	100	\$815.00						
BTUG-6AR	6	Powder Coated	120	\$1,072.00						
BTUG-8AR	8	Aluminum	139	\$1,330.00						

RECYCLED PLASTIC TABLE - RT Series (Catalog Page 37)  3" thick Recycled Plastic walk-through style end frames, top and seat mounting angles and diagonal braces of pre-galvanized steel. Recycled Plastic top and seat planks, portable. Standard frame colors: Black, Brown, or Green - other colors available as special order.				
*Brown Frames with Cedar colored Planks standard				
Model No.	Length (ft.)	Material	Wt. (lbs.)	Price
RT/W-6C	6	*Recycled Plastic	352	\$1,523.00
RT/W-6C/E	6	Frames and	395	\$1,675.00
RT/W-8C	8	2" x 10" Planks	419	\$1,748.00

RECYCLED PLASTIC TABLE - ART Series (Catalog Page 37)  Three 3" thick Recycled Plastic step-over style frames with arched design in Brown or Black colors, Recycled Plastic 2" x 6" top and seat planks in all standard colors, portable.				
*Brown Frames with Cedar colored Planks standard				
Model No.	Length (ft.)	Material	Wt. (lbs.)	Price
ART/W-6C	6	*Recycled Plastic	294	\$1,463.00
ART/W-6C/E1	6	Frames and	326	\$1,573.00
ART/W-8C	8	2" x 6" Planks	352	\$1,660.00

For Black frames replace the /W in the Model Nos. with /B.

*See Pages 57 - 59 for optional lumber species, material color options, and the character designators to specify those options in the Model Numbers.

PORTABLE SQUARE TABLE - SQT Series
(Catalog Page 38)

1-1/2" O.D. x 12 ga. wall structural steel pipe frames, 1-3/4" x 1-3/4" x 10 ga. die-formed steel top and seat angles, 1-5/16" O.D. steel pipe cross braces, portable.

SQT-3: 38" sq. Top
SQT-4: 48" sq. Top

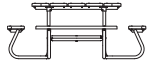

Powder Coated Frames, Black standard */(CB)		Hot-Dip Galvanized Frames (/G)		SQT-3 Series with 38" Square Top		
Model No.	Model No.	Features	Material	Wt. (lbs.)	Price	
SQT/CB-3UP	SQT/G-3UP		*Untreated	168	\$558.00	
SQT/CB-3UP/B	SQT/G-3UP/B	Backrests	#1 Southern Yellow Pine	246	\$833.00	
SQT/CB-3TP	SQT/G-3TP		*Treated	168	\$562.00	
SQT/CB-3TP/B	SQT/G-3TP/B	Backrests	#1 Southern Yellow Pine	246	\$837.00	
SQT/CB-3AL	SQT/G-3AL		Clear Anodized Aluminum	120	\$999.00	
SQT/CB-3AL/B	SQT/G-3AL/B	Backrests	Aluminum	176	\$1,473.00	
SQT/CB-3AR	SQT/G-3AR		*Red Powder Coated Aluminum	120	\$999.00	
SQT/CB-3AR/B	SQT/G-3AR/B	Backrests	Aluminum	176	\$1,473.00	
SQT/CB-3PC	SQT/G-3PC		*Cedar colored Recycled Plastic	205	\$855.00	
SQT/CB-3PC/B	SQT/G-3PC/B	Backrests	Recycled Plastic	303	\$1,257.00	
SQT-4 Series with 48" Square Top						
SQT/CB-4UP	SQT/G-4UP		*Untreated	218	\$644.00	
SQT/CB-4UP/B	SQT/G-4UP/B	Backrests	#1 Southern Yellow Pine	313	\$932.00	
SQT/CB-4TP	SQT/G-4TP		*Treated	218	\$654.00	
SQT/CB-4TP/B	SQT/G-4TP/B	Backrests	#1 Southern Yellow Pine	313	\$942.00	
SQT/CB-4AL	SQT/G-4AL		Clear Anodized Aluminum	146	\$1,262.00	
SQT/CB-4AL/B	SQT/G-4AL/B	Backrests	Aluminum	208	\$1,885.00	
SQT/CB-4AR	SQT/G-4AR		*Red Powder Coated Aluminum	146	\$1,262.00	
SQT/CB-4AR/B	SQT/G-4AR/B	Backrests	Aluminum	208	\$1,885.00	
SQT/CB-4PC	SQT/G-4PC		*Cedar colored Recycled Plastic	273	\$1,093.00	
SQT/CB-4PC/B	SQT/G-4PC/B	Backrests	Recycled Plastic	386	\$1,553.00	
SQT/CB-4VW	SQT/G-4VW		*Brown V-Type Thermo-plastic Coated Expanded Steel	217	\$1,139.00	
SQT/CB-4VW/B	SQT/G-4VW/B	Backrests	Coated Expanded Steel	321	\$1,852.00	
SQT/CB-4HW	SQT/G-4HW		*Brown H-Type Thermo-plastic Coated Perforated Steel	228	\$1,249.00	
SQT/CB-4HW/B	SQT/G-4HW/B	Backrests	Coated Perforated Steel	340	\$1,980.00	
SQTB-4 Series with 48" Square Top and 45" long Contour Bench Seats						
SQTB/CB-4VW	SQTB/G-4VW	48" Square Top, Contour Bench Seats	*Brown V-Type Expanded Steel	365	\$1,666.00	
SQTB/CB-4HW	SQTB/G-4HW		*Brown H-Type Perforated Steel	380	\$1,845.00	

PORTABLE SQUARE WHEELCHAIR ACCESSIBLE TABLE - SQT3-4 Series
(Catalog Page 38)

ADA wheelchair accessible clearances provided with 48" x 59-1/4" extended Top and (1) Seat structure eliminated. 1-1/2" O.D. x 12 ga. wall structural steel pipe frames, 1-3/4" x 1-3/4" x 10 ga. die-formed steel top and seat angles, 1-5/16" O.D. steel pipe cross braces, portable.



Powder Coated Frames, Black standard */(CB)		Hot-Dip Galvanized Frames (/G)		SQT3-4 Series Accessible Table with 48" Extended Top		
Model No.	Model No.	Features	Material	Wt. (lbs.)	Price	
SQT3/CB-4UP/E	SQT3/G-4UP/E	48" x 59-1/4" Extended Top	*Untreated #1 Southern Yellow Pine	205	\$655.00	
SQT3/CB-4TP/E	SQT3/G-4TP/E		*Treated #1 Southern Yellow Pine	205	\$673.00	
SQT3/CB-4PC/E	SQT3/G-4PC/E		*Cedar colored Recycled Plastic	252	\$1,128.00	
SQT3/CB-4VW/E	SQT3/G-4VW/E		*Brown V-Type Expanded Steel	198	\$1,082.00	
SQT3/CB-4HW/E	SQT3/G-4HW/E		*Brown H-Type Perforated Steel	214	\$1,176.00	
SQT3B-4 Series Accessible Table with 48" Extended Top and 45" long Contour Bench Seats						
SQT3B/CB-4VW/E	SQT3B/G-4VW/E	48" x 59-1/4" Extended Top; Contour Seats	*Brown V-Type Expanded Steel	309	\$1,676.00	
SQT3B/CB-4HW/E	SQT3B/G-4HW/E		*Brown H-Type Perforated Steel	328	\$1,825.00	

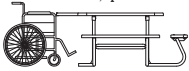

SQUARE PEDESTAL TABLE - PQT Series
(Catalog Page 39)

Central, 5-3/8" square steel post, 3-1/2" O.D. seat support tubes, stationary.

PQT: Long Post for embedded installation
PQT/P: Base Plate Post for surface mount

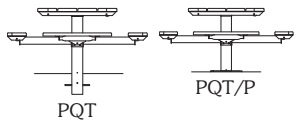

Powder Coated Frames, Black standard */(CB)		Hot-Dip Galvanized Frames (/G)		PQT-3 Series: 38" Square Top with Long Post		
Model No.	Model No.	Material	Wt. (lbs.)	Price		
PQT/CB-3UP	PQT/G-3UP	*Untreated #1 Southern Yellow Pine	246	\$923.00		
PQT/CB-3TP	PQT/G-3TP	*Treated #1 Southern Yellow Pine	246	\$933.00		
PQT/CB-3AL	PQT/G-3AL	Clear Anodized Aluminum	198	\$1,383.00		
PQT/CB-3AR	PQT/G-3AR	*Red Powder Coated Aluminum	198	\$1,383.00		
PQT/CB-3PC	PQT/G-3PC	*Cedar colored Recycled Plastic	283	\$1,238.00		
PQT/P-3 Series: 38" Square Top with Base Plate Post						
PQT/P/CB-3UP	PQT/P/G-3UP	*Untreated #1 Southern Yellow Pine	259	\$923.00		
PQT/P/CB-3TP	PQT/P/G-3TP	*Treated #1 Southern Yellow Pine	259	\$933.00		
PQT/P/CB-3AL	PQT/P/G-3AL	Clear Anodized Aluminum	211	\$1,383.00		
PQT/P/CB-3AR	PQT/P/G-3AR	*Red Powder Coated Aluminum	211	\$1,383.00		
PQT/P/CB-3PC	PQT/P/G-3PC	*Cedar colored Recycled Plastic	296	\$1,238.00		

SQUARE PEDESTAL TABLE - PQT Series ... continued on Page 23

*See Pages 57 - 59 for optional lumber species, material color options, and the character designators to specify those options in the Model Numbers.

RJ Thomas Mfg. Co., Inc.

P.O. Box 946 • Cherokee, Iowa 51012-0946 • ORDERS Toll Free: 800-762-5002 • FAX: 712-225-5796 • 712-225-5115

SQUARE PEDESTAL TABLE -PQT Series (Catalog Page 39) ...continued Central, 5-3/8" square steel post, 3-1/2" O.D. seat support tubes, stationary. PQT: Long Post for embedded installation PQT/P: Base Plate Post for surface mount	Powder Coated Frames, Black standard */(CB)	Hot-Dip Galvanized Frames (/G)			
	PQT-4 Series: 48" Square Top with Long Post				
Model No.	Model No.	Material	Wt. (lbs.)	Price	
PQT/CB-4UP	PQT/G-4UP	*Untreated #1 Southern Yellow Pine	320	\$1,077.00	
PQT/CB-4TP	PQT/G-4TP	*Treated #1 Southern Yellow Pine	320	\$1,095.00	
PQT/CB-4AL	PQT/G-4AL	Clear Anodized Aluminum	248	\$1,767.00	
PQT/CB-4AR	PQT/G-4AR	*Red Powder Coated Aluminum	248	\$1,767.00	
PQT/CB-4PC	PQT/G-4PC	*Cedar colored Recycled Plastic	375	\$1,552.00	
PQT/CB-4VW	PQT/G-4VW	*Brown V-Type Expanded Steel	319	\$1,607.00	
PQT/CB-4HW	PQT/G-4HW	*Brown H-Type Perforated Steel	330	\$1,718.00	
PQT/P-4 Series: 48" Square Top with Base Plate Post					
Model No.	Model No.	Material	Wt. (lbs.)	Price	
PQT/P/CB-4UP	PQT/P/G-4UP	*Untreated #1 Southern Yellow Pine	333	\$1,077.00	
PQT/P/CB-4TP	PQT/P/G-4TP	*Treated #1 Southern Yellow Pine	333	\$1,095.00	
PQT/P/CB-4AL	PQT/P/G-4AL	Clear Anodized Aluminum	261	\$1,767.00	
PQT/P/CB-4AR	PQT/P/G-4AR	*Red Powder Coated Aluminum	261	\$1,767.00	
PQT/P/CB-4PC	PQT/P/G-4PC	*Cedar colored Recycled Plastic	388	\$1,552.00	
PQT/P/CB-4VW	PQT/P/G-4VW	*Brown V-Type Expanded Steel	332	\$1,607.00	
PQT/P/CB-4HW	PQT/P/G-4HW	*Brown H-Type Perforated Steel	343	\$1,718.00	
PQTB-4 Series: 48" Square Top with 45" long Contour Bench Seats and Long Post					
Model No.	Model No.	Material	Wt. (lbs.)	Price	
PQTB/CB-4VW	PQTB/G-4VW	*Brown V-Type Expanded Steel	467	\$2,135.00	
PQTB/CB-4HW	PQTB/G-4HW	*Brown H-Type Perforated Steel	482	\$2,312.00	
PQTB/P-4 Series: 48" Square Top with 45" long Contour Bench Seats and Base Plate Post					
Model No.	Model No.	Material	Wt. (lbs.)	Price	
PQTB/P/CB-4VW	PQTB/P/G-4VW	*Brown V-Type Expanded Steel	480	\$2,135.00	
PQTB/P/CB-4HW	PQTB/P/G-4HW	*Brown H-Type Perforated Steel	495	\$2,312.00	

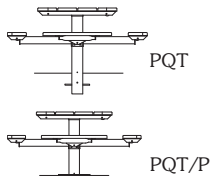

SQUARE PEDESTAL WHEELCHAIR ACCESSIBLE TABLE -PQT3-4 Series (Catalog Page 39) ADA wheelchair accessible clearances provided with 48" square Top and (1) Seat structure eliminated. (3) Seats, Central, 5-3/8" square steel post, 3-1/2" O.D. seat support tubes, stationary. PQT3-4: Long Post for embedded installation PQT3/P-4: Base Plate Post for surface mount	Powder Coated Frames, Black standard */(CB)	Hot-Dip Galvanized Frames (/G)			
	PQT3-4 Series: 48" Square Top with Long Post				
Model No.	Model No.	Material	Wt. (lbs.)	Price	
PQT3/CB-4UP	PQT3/G-4UP	*Untreated #1 Southern Yellow Pine	279	\$956.00	
PQT3/CB-4TP	PQT3/G-4TP	*Treated #1 Southern Yellow Pine	279	\$975.00	
PQT3/CB-4AL	PQT3/G-4AL	Clear Anodized Aluminum	215	\$1,544.00	
PQT3/CB-4AR	PQT3/G-4AR	*Red Powder Coated Aluminum	215	\$1,544.00	
PQT3/CB-4PC	PQT3/G-4PC	*Cedar colored Recycled Plastic	329	\$1,351.00	
PQT3/CB-4VW	PQT3/G-4VW	*Brown V-Type Expanded Steel	276	\$1,391.00	
PQT3/CB-4HW	PQT3/G-4HW	*Brown H-Type Perforated Steel	285	\$1,485.00	
PQT3/P-4 Series: 48" Square Top with Base Plate Post					
Model No.	Model No.	Material	Wt. (lbs.)	Price	
PQT3/P/CB-4UP	PQT3/P/G-4UP	*Untreated #1 Southern Yellow Pine	292	\$956.00	
PQT3/P/CB-4TP	PQT3/P/G-4TP	*Treated #1 Southern Yellow Pine	292	\$975.00	
PQT3/P/CB-4AL	PQT3/P/G-4AL	Clear Anodized Aluminum	228	\$1,544.00	
PQT3/P/CB-4AR	PQT3/P/G-4AR	*Red Powder Coated Aluminum	228	\$1,544.00	
PQT3/P/CB-4PC	PQT3/P/G-4PC	*Cedar colored Recycled Plastic	342	\$1,351.00	
PQT3/P/CB-4VW	PQT3/P/G-4VW	*Brown V-Type Expanded Steel	289	\$1,391.00	
PQT3/P/CB-4HW	PQT3/P/G-4HW	*Brown H-Type Perforated Steel	298	\$1,485.00	
PQT3B-4 Series: 48" Square Top with 45" long Contour Bench Seats and Long Post					
Model No.	Model No.	Material	Wt. (lbs.)	Price	
PQT3B/CB-4VW	PQT3B/G-4VW	*Brown V-Type Expanded Steel	387	\$1,748.00	
PQT3B/CB-4HW	PQT3B/G-4HW	*Brown H-Type Perforated Steel	399	\$1,904.00	
PQT3B/P-4 Series: 48" Square Top with 45" long Contour Bench Seats and Base Plate Post					
Model No.	Model No.	Material	Wt. (lbs.)	Price	
PQT3B/P/CB-4VW	PQT3B/P/G-4VW	*Brown V-Type Expanded Steel	400	\$1,748.00	
PQT3B/P/CB-4HW	PQT3B/P/G-4HW	*Brown H-Type Perforated Steel	412	\$1,904.00	

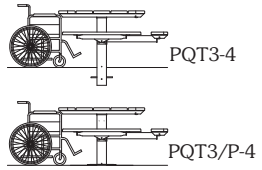

*See Pages 57 – 59 for optional lumber species, material color options, and the character designators to specify those options in the Model Numbers.

ROUND TABLES
-T100, T200, T300,
T400 Series
 (Catalog Pages 40 & 41)

48" dia. Round Top. (4) Seats in choice of Curved, Round, Chair, or Bench designs depending on Table Model. (3) Seats with wheelchair opening on (1) side available on T300 and T400 Series.



T100



T200

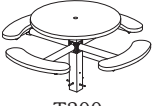

T300

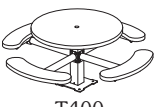

T400

Powder Coated Frames, Black standard *(/CB)		Hot-Dip Galvanized Frames (/G)		T100 Series -Portable		
Model No.	Model No.	Seat Style	Material	Wt. (lbs.)	Price	
T104/CB-4PC	T104/G-4PC	4 Curved	*Cedar colored Recycled Plastic	294	\$1,458.00	
T104/CB-4DW	T104/G-4DW	4 Curved	*Brown D-Type Expanded Steel	278	\$1,188.00	
T134/CB-4DW	T134/G-4DW	4 Bench	*Brown R-Type Perforated Steel	378	\$1,674.00	
T104/CB-4RW	T104/G-4RW	4 Curved		286	\$1,321.00	
T134/CB-4RW	T134/G-4RW	4 Bench	*Brown Cut Steel Plate	378	\$1,788.00	
T104/CB-4SP/TW	T104/G-4SP/TW	4 Curved		268	\$1,254.00	

Powder Coated Frames, Black standard *(/CB)		Hot-Dip Galvanized Frames (/G)		T200 Series -Portable		
Model No.	Model No.	Seat Style	Material	Wt. (lbs.)	Price	
T214/CB-4PC	T214/G-4PC	4 Round	*Cedar colored Recycled Plastic	246	\$1,284.00	
T204/CB-4DW	T204/G-4DW	4 Curved	*Brown D-Type Thermo-plastic Coated Expanded Steel	274	\$1,285.00	
T214/CB-4DW	T214/G-4DW	4 Round		238	\$981.00	
T224/CB-4DW	T224/G-4DW	4 Chair	*Brown R-Type Thermo-plastic Coated Perforated Steel	294	\$1,280.00	
T204/CB-4RW	T204/G-4RW	4 Curved		282	\$1,430.00	
T214/CB-4RW	T214/G-4RW	4 Round	*Brown Thermo-plastic Coated Cut Steel Plate	274	\$1,053.00	
T224/CB-4RW	T224/G-4RW	4 Chair		294	\$1,369.00	
T204/CB-4SP/TW	T204/G-4SP/TW	4 Curved	*Brown Thermo-plastic Coated Cut Steel Plate	264	\$1,360.00	
T214/CB-4SP/TW	T214/G-4SP/TW	4 Round		252	\$1,245.00	

Powder Coated Frames, Black standard *(/CB)		Hot-Dip Galvanized Frames (/G)		T300 Series -Embedded Mount Long Post		
Model No.	Model No.	Seat Style	Material	Wt. (lbs.)	Price	
T304/CB-4PC	T304/G-4PC	4 Curved	*Cedar colored Recycled Plastic	384	\$1,656.00	
T303/CB-4PC	T303/G-4PC	3 Curved	*Brown D-Type Thermo-plastic Coated Expanded Steel	336	\$1,456.00	
T304/CB-4DW	T304/G-4DW	4 Curved		343	\$1,647.00	
T334/CB-4DW	T334/G-4DW	4 Bench	*Brown R-Type Thermo-plastic Coated Perforated Steel	443	\$2,133.00	
T303/CB-4DW	T303/G-4DW	3 Curved		320	\$1,380.00	
T333/CB-4DW	T333/G-4DW	3 Bench	*Brown Thermo-plastic Coated Cut Steel Plate	395	\$1,744.00	
T304/CB-4RW	T304/G-4RW	4 Curved		351	\$1,780.00	
T334/CB-4RW	T334/G-4RW	4 Bench	*Brown Thermo-plastic Coated Cut Steel Plate	443	\$2,247.00	
T303/CB-4RW	T303/G-4RW	3 Curved		326	\$1,486.00	
T333/CB-4RW	T333/G-4RW	3 Bench	*Brown Thermo-plastic Coated Cut Steel Plate	395	\$1,839.00	
T304/CB-4SP/TW	T304/G-4SP/TW	4 Curved		352	\$1,713.00	
T303/CB-4SP/TW	T303/G-4SP/TW	3 Curved	332	\$1,464.00		

Powder Coated Frames, Black standard *(/CB)		Hot-Dip Galvanized Frames (/G)		T400 Series -Surface Mount Base Plate Post		
Model No.	Model No.	Seat Style	Material	Wt. (lbs.)	Price	
T404/CB-4PC	T404/G-4PC	4 Curved	*Cedar colored Recycled Plastic	397	\$1,702.00	
T403/CB-4PC	T403/G-4PC	3 Curved	*Brown D-Type Thermo-plastic Coated Expanded Steel	350	\$1,502.00	
T404/CB-4DW	T404/G-4DW	4 Curved		343	\$1,693.00	
T434/CB-4DW	T434/G-4DW	4 Bench	*Brown R-Type Thermo-plastic Coated Perforated Steel	443	\$2,179.00	
T403/CB-4DW	T403/G-4DW	3 Curved		320	\$1,426.00	
T433/CB-4DW	T433/G-4DW	3 Bench	*Brown Thermo-plastic Coated Cut Steel Plate	395	\$1,790.00	
T404/CB-4RW	T404/G-4RW	4 Curved		351	\$1,826.00	
T434/CB-4RW	T434/G-4RW	4 Bench	*Brown Thermo-plastic Coated Cut Steel Plate	443	\$2,293.00	
T403/CB-4RW	T403/G-4RW	3 Curved		326	\$1,532.00	
T433/CB-4RW	T433/G-4RW	3 Bench	*Brown Thermo-plastic Coated Cut Steel Plate	395	\$1,885.00	
T404/CB-4SP/TW	T404/G-4SP/TW	4 Curved		352	\$1,759.00	
T403/CB-4SP/TW	T403/G-4SP/TW	3 Curved	332	\$1,510.00		

*See Pages 57 – 59 for optional lumber species, material color options, and the character designators to specify those options in the Model Numbers.

MULTI-PEDESTAL TABLE - APT Series
(Catalog Page 42)

Multiple, 3" x 6" x 1/8" wall rectangular steel tubing Pedestal Post frames.

APT: Long Posts for embedded installation

APT/P: Base Plate Posts for surface mount

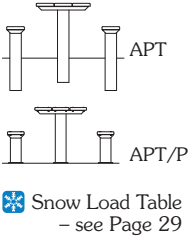

Powder Coated Frames, Black standard *(/CB)		Hot-Dip Galvanized Frames (/G)			
APT Series 6 ft. with Long Posts					
Model No.	Model No.	Material	Wt. (lbs.)	Price	
APT/CB-6UP	APT/G-6UP	*Untreated #1 Southern Yellow Pine	266	\$791.00	
APT/CB-6TP	APT/G-6TP	*Treated #1 Southern Yellow Pine	266	\$801.00	
APT/CB-6AL	APT/G-6AL	Clear Anodized Aluminum	211	\$1,388.00	
APT/CB-6AR	APT/G-6AR	*Red Powder Coated Aluminum	211	\$1,388.00	
APT/CB-6PC	APT/G-6PC	*Cedar colored Recycled Plastic	350	\$1,314.00	
APT/CB-6VW ❄	APT/G-6VW ❄	*Brown V-Type Expanded Steel	297	\$1,549.00	
APT/CB-6DW	APT/G-6DW	*Brown D-Type Expanded Steel	265	\$1,355.00	
APT/CB-6HW ❄	APT/G-6HW ❄	*Brown H-Type Perforated Steel	307	\$1,575.00	
APT/CB-6RW	APT/G-6RW	*Brown R-Type Perforated Steel	271	\$1,487.00	
APT/CB-6SC/TW	APT/G-6SC/TW	*Brown Formed Steel Channel	318	\$1,514.00	
APT/P Series 6 ft. with Base Plate Posts					
Model No.	Model No.	Material	Wt. (lbs.)	Price	
APT/P/CB-6UP	APT/P/G-6UP	*Untreated #1 Southern Yellow Pine	266	\$791.00	
APT/P/CB-6TP	APT/P/G-6TP	*Treated #1 Southern Yellow Pine	266	\$801.00	
APT/P/CB-6AL	APT/P/G-6AL	Clear Anodized Aluminum	211	\$1,388.00	
APT/P/CB-6AR	APT/P/G-6AR	*Red Powder Coated Aluminum	211	\$1,388.00	
APT/P/CB-6PC	APT/P/G-6PC	*Cedar colored Recycled Plastic	350	\$1,314.00	
APT/P/CB-6VW ❄	APT/P/G-6VW ❄	*Brown V-Type Expanded Steel	297	\$1,549.00	
APT/P/CB-6DW	APT/P/G-6DW	*Brown D-Type Expanded Steel	265	\$1,355.00	
APT/P/CB-6HW ❄	APT/P/G-6HW ❄	*Brown H-Type Perforated Steel	307	\$1,575.00	
APT/P/CB-6RW	APT/P/G-6RW	*Brown R-Type Perforated Steel	271	\$1,487.00	
APT/P/CB-6SC/TW	APT/P/G-6SC/TW	*Brown Formed Steel Channel	318	\$1,514.00	

Powder Coated Frames, Black standard *(/CB)		Hot-Dip Galvanized Frames (/G)			
APT Series 8 ft. with Long Posts					
Model No.	Model No.	Material	Wt. (lbs.)	Price	
APT/CB-8UP	APT/G-8UP	*Untreated #1 Southern Yellow Pine	304	\$849.00	
APT/CB-8TP	APT/G-8TP	*Treated #1 Southern Yellow Pine	304	\$864.00	
APT/CB-8AL	APT/G-8AL	Clear Anodized Aluminum	230	\$1,646.00	
APT/CB-8AR	APT/G-8AR	*Red Powder Coated Aluminum	230	\$1,646.00	
APT/CB-8PC	APT/G-8PC	*Cedar colored Recycled Plastic	414	\$1,527.00	
APT/CB-8VW ❄	APT/G-8VW ❄	*Brown V-Type Expanded Steel	337	\$1,791.00	
APT/CB-8DW	APT/G-8DW	*Brown D-Type Expanded Steel	295	\$1,499.00	
APT/CB-8HW ❄	APT/G-8HW ❄	*Brown H-Type Perforated Steel	351	\$1,866.00	
APT/CB-8RW	APT/G-8RW	*Brown R-Type Perforated Steel	316	\$1,571.00	
APT/CB-8SC/TW	APT/G-8SC/TW	*Brown Formed Steel Channel	356	\$1,675.00	
APT/P Series 8 ft. with Base Plate Posts					
Model No.	Model No.	Material	Wt. (lbs.)	Price	
APT/P/CB-8UP	APT/P/G-8UP	*Untreated #1 Southern Yellow Pine	304	\$849.00	
APT/P/CB-8TP	APT/P/G-8TP	*Treated #1 Southern Yellow Pine	304	\$864.00	
APT/P/CB-8AL	APT/P/G-8AL	Clear Anodized Aluminum	230	\$1,646.00	
APT/P/CB-8AR	APT/P/G-8AR	*Red Powder Coated Aluminum	230	\$1,646.00	
APT/P/CB-8PC	APT/P/G-8PC	*Cedar colored Recycled Plastic	414	\$1,527.00	
APT/P/CB-8VW ❄	APT/P/G-8VW ❄	*Brown V-Type Expanded Steel	337	\$1,791.00	
APT/P/CB-8DW	APT/P/G-8DW	*Brown D-Type Expanded Steel	295	\$1,499.00	
APT/P/CB-8HW ❄	APT/P/G-8HW ❄	*Brown H-Type Perforated Steel	351	\$1,866.00	
APT/P/CB-8RW	APT/P/G-8RW	*Brown R-Type Perforated Steel	316	\$1,571.00	
APT/P/CB-8SC/TW	APT/P/G-8SC/TW	*Brown Formed Steel Channel	356	\$1,675.00	

MULTI-PEDESTAL TABLE - APT Series ... continued on Page 26

*See Pages 57 - 59 for optional lumber species, material color options, and the character designators to specify those options in the Model Numbers.

MULTI-PEDESTAL WHEELCHAIR ACCESSIBLE TABLE - APT Series
(Catalog Page 42) ...continued

Multiple, 3" x 6" x 1/8" wall rectangular steel tubing Pedestal Post frames. 6 ft. table with 8 ft. Top extended 1 ft. each end beyond 6 ft. Seats.

APT: Long Posts for embedded installation
APT/P: Base Plate Posts for surface mount.

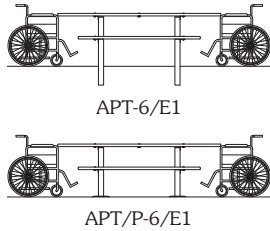

Powder Coated Frames, Black standard *(/CB)		Hot-Dip Galvanized Frames (/G)			
APT Series Accessible Tables with Long Posts					
Model No.	Model No.	Material	Wt. (lbs.)	Price	
APT/CB-6UP/E1	APT/G-6UP/E1	*Untreated #1 Southern Yellow Pine	289	\$827.00	
APT/CB-6TP/E1	APT/G-6TP/E1	*Treated #1 Southern Yellow Pine	289	\$837.00	
APT/CB-6AL/E1	APT/G-6AL/E1	Clear Anodized Aluminum	222	\$1,543.00	
APT/CB-6AR/E1	APT/G-6AR/E1	*Red Powder Coated Aluminum	222	\$1,543.00	
APT/CB-6PC/E1	APT/G-6PC/E1	*Cedar colored Recycled Plastic	393	\$1,434.00	
APT/CB-6VW/E1	APT/G-6VW/E1	*Brown V-Type Expanded Steel	323	\$1,721.00	
APT/CB-6DW/E1	APT/G-6DW/E1	*Brown D-Type Expanded Steel	281	\$1,423.00	
APT/CB-6HW/E1	APT/G-6HW/E1	*Brown H-Type Perforated Steel	333	\$1,752.00	
APT/CB-6RW/E1	APT/G-6RW/E1	*Brown R-Type Perforated Steel	292	\$1,537.00	
APT/CB-6SC/TW/E1	APT/G-6SC/TW/E1	*Brown Formed Steel Channel	336	\$1,563.00	
APT/P Series Accessible Tables with Base Plate Posts					
Model No.	Model No.	Material	Wt. (lbs.)	Price	
APT/P/CB-6UP/E1	APT/P/G-6UP/E1	*Untreated #1 Southern Yellow Pine	289	\$827.00	
APT/P/CB-6TP/E1	APT/P/G-6TP/E1	*Treated #1 Southern Yellow Pine	289	\$837.00	
APT/P/CB-6AL/E1	APT/P/G-6AL/E1	Clear Anodized Aluminum	222	\$1,543.00	
APT/P/CB-6AR/E1	APT/P/G-6AR/E1	*Red Powder Coated Aluminum	222	\$1,543.00	
APT/P/CB-6PC/E1	APT/P/G-6PC/E1	*Cedar colored Recycled Plastic	393	\$1,434.00	
APT/P/CB-6VW/E1	APT/P/G-6VW/E1	*Brown V-Type Expanded Steel	323	\$1,721.00	
APT/P/CB-6DW/E1	APT/P/G-6DW/E1	*Brown D-Type Expanded Steel	281	\$1,423.00	
APT/P/CB-6HW/E1	APT/P/G-6HW/E1	*Brown H-Type Perforated Steel	333	\$1,752.00	
APT/P/CB-6RW/E1	APT/P/G-6RW/E1	*Brown R-Type Perforated Steel	292	\$1,537.00	
APT/P/CB-6SC/TW/E1	APT/P/G-6SC/TW/E1	*Brown Formed Steel Channel	336	\$1,563.00	

MULTI-PEDESTAL TABLE - APT Series with 3" x 4" Recycled Plastic Timbers
(Catalog Page 42)

Multiple, 3" x 6" x 1/8" wall rectangular steel tubing Pedestal Post frames.

APT: Long Posts for embedded installation
APT/P: Base Plate Posts for surface mount

Wheelchair Accessible:
Multiple, 3" x 6" x 1/8" wall rectangular steel tubing Pedestal Post frames. 6 ft. table with 8 ft. Top extended 1 ft. each end beyond 6 ft. Seats.

APT: Long Posts for embedded installation
APT/P: Base Plate Posts for surface mount.

Powder Coated Frames, Black standard *(/CB)		Hot-Dip Galvanized Frames (/G)			
APT Series with Long Posts					
Model No.	Model No.	Length (ft.)	Material	Wt. (lbs.)	Price
APT/CB-6PC34	APT/G-6PC34	6	*Cedar colored Recycled Plastic 3" x 4" Timbers	487	\$2,198.00
APT/CB-8PC34	APT/G-8PC34	8		597	\$2,574.00
APT/P Series with Base Plate Posts					
Model No.	Model No.	Length (ft.)	Material	Wt. (lbs.)	Price
APT/P/CB-6PC34	APT/P/G-6PC34	6	*Cedar colored Recycled Plastic 3" x 4" Timbers	487	\$2,198.00
APT/P/CB-8PC34	APT/P/G-8PC34	8		597	\$2,574.00
APT Series Accessible Table with Long Posts					
Model No.	Model No.	Material	Wt. (lbs.)	Price	
APT/CB-6PC34/E1	APT/G-6PC34/E1	*Cedar colored Recycled Plastic 3" x 4" Timbers	548	\$2,409.00	
APT/P Series Accessible Table with Base Plate Posts					
Model No.	Model No.	Material	Wt. (lbs.)	Price	
APT/P/CB-6PC34/E1	APT/P/G-6PC34/E1	*Cedar colored Recycled Plastic 3" x 4" Timbers	548	\$2,409.00	

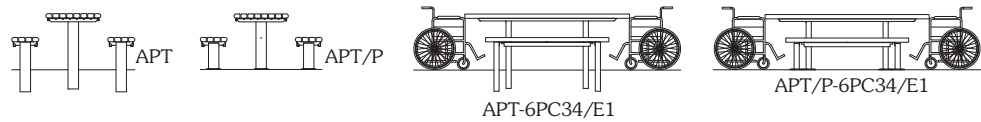

TWIN PEDESTAL TABLE - TPT Series
(Catalog Page 43)

Twin, 4" x 1/8" wall, square steel tubing Support Posts with 2-1/2" x 3/16" wall, square steel tubing Seat Support Arms.

TPT: Long Posts for embedded installation
TPT/P: Base Plate Posts for surface mount

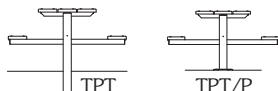

Powder Coated Frames, Black standard *(/CB)		Hot-Dip Galvanized Frames (/G)			
TPT Series with Long Posts					
Model No.	Model No.	Length (ft.)	Material	Wt. (lbs.)	Price
TPT/CB-6UP	TPT/G-6UP	6	*Untreated #1 Southern Yellow Pine	227	\$722.00
TPT/CB-8UP	TPT/G-8UP	8		265	\$781.00
TPT/CB-10UP	TPT/G-10UP	10		360	\$1,112.00
TPT/CB-6TP	TPT/G-6TP	6	*Treated #1 Southern Yellow Pine	227	\$733.00
TPT/CB-8TP	TPT/G-8TP	8		265	\$796.00
TPT/CB-10TP	TPT/G-10TP	10		360	\$1,130.00
TPT/CB-6AL	TPT/G-6AL	6	Clear Anodized Aluminum	172	\$1,321.00
TPT/CB-8AL	TPT/G-8AL	8		191	\$1,579.00
TPT/CB-10AL	TPT/G-10AL	10		267	\$2,110.00

TWIN PEDESTAL TABLE - TPT Series ... continued on Page 27

*See Pages 57 - 59 for optional lumber species, material color options, and the character designators to specify those options in the Model Numbers.

RJ Thomas Mfg. Co., Inc.

P.O. Box 946 • Cherokee, Iowa 51012-0946 • ORDERS Toll Free: 800-762-5002 • FAX: 712-225-5796 • 712-225-5115

TWIN PEDESTAL TABLE - TPT Series
(Catalog Page 43) ...continued

Twin, 4" x 1/8" wall, square steel tubing Support Posts with 2-1/2" x 3/16" wall, square steel tubing Seat Support Arms.

TPT: Long Posts for embedded installation

TPT/P: Base Plate Posts for surface mount

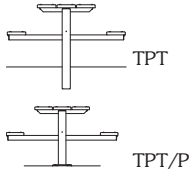

Powder Coated Frames, Black standard *(/CB)		Hot-Dip Galvanized Frames (/G)		TPT Series with Long Posts ...continued		
Model No.	Model No.	Length (ft.)	Material	Wt. (lbs.)	Price	
TPT/CB-6AR	TPT/G-6AR	6	*Red Powder Coated Aluminum	172	\$1,321.00	
TPT/CB-8AR	TPT/G-8AR	8		191	\$1,579.00	
TPT/CB-10AR	TPT/G-10AR	10		267	\$2,110.00	
TPT/CB-6PC	TPT/G-6PC	6	*Cedar colored Recycled Plastic	311	\$1,246.00	
TPT/CB-8PC	TPT/G-8PC	8		375	\$1,459.00	
TPT/CB-6DW	TPT/G-6DW	6	*Brown D-Type Thermo-plastic Coated Expanded Steel	226	\$1,288.00	
TPT/CB-8DW	TPT/G-8DW	8		256	\$1,430.00	
TPT/CB-10DW	TPT/G-10DW	10		346	\$1,884.00	
TPT/CB-6RW	TPT/G-6RW	6	*Brown R-Type Thermo-plastic Coated Perforated Steel	232	\$1,418.00	
TPT/CB-8RW	TPT/G-8RW	8		277	\$1,504.00	
TPT/CB-10RW	TPT/G-10RW	10		362	\$2,042.00	
TPT/CB-6SC/TW	TPT/G-6SC/TW	6	*Brown Thermo-plastic Coated Formed Steel Channel	279	\$1,501.00	
TPT/CB-8SC/TW	TPT/G-8SC/TW	8		317	\$1,663.00	
TPT/P Series with Base Plate Posts						
Model No.	Model No.	Length (ft.)	Material	Wt. (lbs.)	Price	
TPT/P/CB-6UP	TPT/P/G-6UP	6	*Untreated #1 Southern Yellow Pine	241	\$722.00	
TPT/P/CB-8UP	TPT/P/G-8UP	8		279	\$781.00	
TPT/P/CB-10UP	TPT/P/G-10UP	10		381	\$1,112.00	
TPT/P/CB-6TP	TPT/P/G-6TP	6	*Treated #1 Southern Yellow Pine	241	\$733.00	
TPT/P/CB-8TP	TPT/P/G-8TP	8		279	\$796.00	
TPT/P/CB-10TP	TPT/P/G-10TP	10		381	\$1,130.00	
TPT/P/CB-6AL	TPT/P/G-6AL	6	Clear Anodized Aluminum	186	\$1,321.00	
TPT/P/CB-8AL	TPT/P/G-8AL	8		205	\$1,579.00	
TPT/P/CB-10AL	TPT/P/G-10AL	10		288	\$2,110.00	
TPT/P/CB-6AR	TPT/P/G-6AR	6	*Red Powder Coated Aluminum	186	\$1,321.00	
TPT/P/CB-8AR	TPT/P/G-8AR	8		205	\$1,579.00	
TPT/P/CB-10AR	TPT/P/G-10AR	10		288	\$2,110.00	
TPT/P/CB-6PC	TPT/P/G-6PC	6	*Cedar colored Recycled Plastic	325	\$1,246.00	
TPT/P/CB-8PC	TPT/P/G-8PC	8		389	\$1,459.00	
TPT/P/CB-6DW	TPT/P/G-6DW	6	*Brown D-Type Thermo-plastic Coated Expanded Steel	240	\$1,288.00	
TPT/P/CB-8DW	TPT/P/G-8DW	8		270	\$1,430.00	
TPT/P/CB-10DW	TPT/P/G-10DW	10		367	\$1,884.00	
TPT/P/CB-6RW	TPT/P/G-6RW	6	*Brown R-Type Thermo-plastic Coated Perforated Steel	246	\$1,418.00	
TPT/P/CB-8RW	TPT/P/G-8RW	8		291	\$1,504.00	
TPT/P/CB-10RW	TPT/P/G-10RW	10		383	\$2,042.00	
TPT/P/CB-6SC/TW	TPT/P/G-6SC/TW	6	*Brown Thermo-plastic Coated Formed Steel Channel	293	\$1,501.00	
TPT/P/CB-8SC/TW	TPT/P/G-8SC/TW	8		331	\$1,663.00	

TWIN PEDESTAL WHEELCHAIR ACCESSIBLE TABLE - TPT Series
(Catalog Page 43)

Twin, 4" x 1/8" wall, square steel tubing Support Posts with 2-1/2" x 3/16" wall, square steel tubing Seat Support Arms. 6 ft. table with 8 ft. Top extended 2 ft. on one end beyond 6 ft. Seats (/E), or 1 ft. each end (/E1).

TPT: Long Posts for embedded installation

TPT/P: Base Plate Posts for surface mount

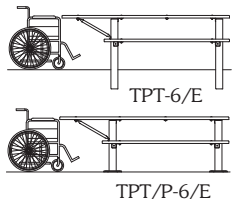

Powder Coated Frames, Black standard *(/CB)		Hot-Dip Galvanized Frames (/G)		TPT Series Accessible Tables with Long Posts		
Model No.	Model No.	Length (ft.)	Material	Wt. (lbs.)	Price	
TPT/CB-6UP/E	TPT/G-6UP/E	Top 8, Seats 6	*Untreated Pine	255	\$789.00	
TPT/CB-6TP/E	TPT/G-6TP/E		*Treated Pine	255	\$800.00	
TPT/CB-6AL/E	TPT/G-6AL/E		Clear Anodized Aluminum	188	\$1,506.00	
TPT/CB-6AR/E	TPT/G-6AR/E		*Red Powder Coated Aluminum	188	\$1,506.00	
TPT/CB-6PC/E	TPT/G-6PC/E		*Cedar colored Recycled Plastic	354	\$1,396.00	
TPT/CB-6DW/E	TPT/G-6DW/E		*Brown D-Type Expanded Steel	247	\$1,384.00	
TPT/CB-6RW/E	TPT/G-6RW/E		*Brown R-Type Perforated Steel	258	\$1,499.00	
TPT/CB-6SC/TW/E	TPT/G-6SC/TW/E		*Brown Formed Steel Channel	302	\$1,526.00	
TPT/P Series Accessible Tables with Base Plate Posts						
Model No.	Model No.	Length (ft.)	Material	Wt. (lbs.)	Price	
TPT/P/CB-6UP/E	TPT/P/G-6UP/E	Top 8, Seats 6	*Untreated Pine	269	\$789.00	
TPT/P/CB-6TP/E	TPT/P/G-6TP/E		*Treated Pine	269	\$800.00	
TPT/P/CB-6AL/E	TPT/P/G-6AL/E		Clear Anodized Aluminum	202	\$1,506.00	
TPT/P/CB-6AR/E	TPT/P/G-6AR/E		*Red Powder Coated Aluminum	202	\$1,506.00	
TPT/P/CB-6PC/E	TPT/P/G-6PC/E		*Cedar colored Recycled Plastic	368	\$1,396.00	
TPT/P/CB-6DW/E	TPT/P/G-6DW/E		*Brown D-Type Expanded Steel	261	\$1,384.00	
TPT/P/CB-6RW/E	TPT/P/G-6RW/E		*Brown R-Type Perforated Steel	272	\$1,499.00	
TPT/P/CB-6SC/TW/E	TPT/P/G-6SC/TW/E		*Brown Formed Steel Channel	316	\$1,526.00	

*See Pages 57 – 59 for optional lumber species, material color options, and the character designators to specify those options in the Model Numbers.



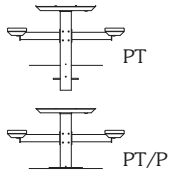



SINGLE PEDESTAL TABLE -PT Series (Catalog Page 43) 	Powder Coated Frames, Black standard *(/CB)	Hot-Dip Galvanized Frames (/G)			
	PT Series with Long Post				
	Model No.	Model No.	Material	Wt. (lbs.)	Price
Single, 5-3/8" Square Steel Post, 3-1/2" O.D. seat support tubes, stationary. 6 ft. only. PT: Long Post for embedded installation PT/P: Base Plate Post for surface mount	PT/CB-6UP	PT/G-6UP	*Untreated #1 Southern Yellow Pine	260	\$863.00
	PT/CB-6TP	PT/G-6TP	*Treated #1 Southern Yellow Pine	260	\$873.00
	PT/CB-6AL	PT/G-6AL	Clear Anodized Aluminum	205	\$1,461.00
	PT/CB-6AR	PT/G-6AR	*Red Powder Coated Aluminum	205	\$1,461.00
	PT/CB-6PC	PT/G-6PC	*Cedar colored Recycled Plastic	306	\$1,281.00
	PT/CB-6DW	PT/G-6DW	*Brown D-Type Expanded Steel	259	\$1,428.00
	PT/CB-6RW	PT/G-6RW	*Brown R-Type Perforated Steel	265	\$1,559.00
	PT/CB-6SC/TW	PT/G-6SC/TW	*Brown Formed Steel Channel	312	\$1,586.00
PT/P Series with Base Plate Post					
Model No.	Model No.	Material	Wt. (lbs.)	Price	
PT/P/CB-6UP	PT/P/G-6UP	*Untreated #1 Southern Yellow Pine	273	\$863.00	
PT/P/CB-6TP	PT/P/G-6TP	*Treated #1 Southern Yellow Pine	273	\$873.00	
PT/P/CB-6AL	PT/P/G-6AL	Clear Anodized Aluminum	218	\$1,461.00	
PT/P/CB-6AR	PT/P/G-6AR	*Red Powder Coated Aluminum	218	\$1,461.00	
PT/P/CB-6PC	PT/P/G-6PC	*Cedar colored Recycled Plastic	319	\$1,281.00	
PT/P/CB-6DW	PT/P/G-6DW	*Brown D-Type Expanded Steel	272	\$1,428.00	
PT/P/CB-6RW	PT/P/G-6RW	*Brown R-Type Perforated Steel	278	\$1,559.00	
PT/P/CB-6SC/TW	PT/P/G-6SC/TW	*Brown Formed Steel Channel	312	\$1,586.00	



SQUARE FRAME PICNIC and UTILITY TABLES -T700 Series (Catalog Page 44)

Square end frame design with 2" x 2" x 11 ga. square steel tube end frames, surface mount only. 1" x 2" x 14 ga. rectangular steel tube top and seat frames with formed steel reinforcements, factory inlaid 2" x 4" nom. recycled plastic top and seat slats. Most models provide ADA compliant access.



Powder Coated Frames, Black standard *(/CB) Model No.	Length (ft.)	Bench Seats	ADA Compliant Access 	Top and Seat Inlay Material	Wt. (lbs.)	Price
T700 Series Rectangular UTILITY TABLES						
T700/CB-6PC	6, Rectangular	None	 Yes - All Sides	*Cedar Colored Recycled Plastic	163	\$687.00
T700/CB-8PC	8, Rectangular	None	 Yes - All Sides		211	\$814.00
T702 Series Rectangular PICNIC TABLES						
T702/CB-6PC	6, Rectangular	(2) 6 ft.	 Yes - Both Ends	*Cedar Colored Recycled Plastic	419	\$1,570.00
T702/CB-8PC	8, Rectangular	(2) 8 ft.	 Yes - Both Ends		471	\$1,829.00
TQ700 Series Square UTILITY TABLES						
TQ700/CB-4PC	4, Square	None	 Yes - All Sides	*Cedar Colored Recycled Plastic	145	\$639.00
TQ703 Series Square PICNIC TABLES						
TQ703/CB-4PC	4, Square	(3) 4 ft.	 Yes - (1) Side	*Cedar Colored Recycled Plastic	382	\$1,773.00
TQ704 Series Square PICNIC TABLES						
TQ704/CB-4PC	4, Square	(4) 4 ft.	No	*Cedar Colored Recycled Plastic	461	\$2,150.00

FOOD COURT TABLES -FCT Series (Catalog Page 45)	Powder Coated Frames Black standard *(/CB)	Hot-Dip Galvanized Frames (/G)				
						
	Model No.	Model No.	Installation	Material	Wt. (lbs.)	Price
Open span frame design. 48" long Top and Seats, 58" overall width. 2-3/8" O.D. steel pipe frames (2.375" O.D., 11 ga. wall, 2" I.D. nom. pipe specifications), 10 ga. steel, die-formed top and seat support and attachment brackets. FCT: Surface mount, bolt-down installation with concrete screw anchors included FCTL: Portable, (4) Levelers to adapt to uneven surfaces	FCT/CB-4RW	FCT/G-4RW	Surface Mount (bolt down)	*Brown Thermo-plastic Coated, R-Type Perforated Steel	140	\$951.00
	FCT/CB-4SP/CWT	FCT/G-4SP/CWT		*Brown Textured Powder Coated Solid Steel Plate	155	\$951.00
	FCTL/CB-4RW	FCTL/G-4RW	(4) Levelers	*Brown Thermo-plastic Coated, R-Type Perforated Steel	140	\$951.00
	FCTL/CB-4SP/CWT	FCTL/G-4SP/CWT		*Brown Textured Powder Coated Solid Steel Plate	155	\$951.00

*See Pages 57 - 59 for optional lumber species, material color options, and the character designators to specify those options in the Model Numbers.

RJ Thomas Mfg. Co., Inc.

P.O. Box 946 • Cherokee, Iowa 51012-0946 • ORDERS Toll Free: 800-762-5002 • FAX: 712-225-5796 • 712-225-5115

SNOW LOAD and EXTREME LOAD RATED TABLES
(Catalog Page 46)

Pilot Rock tables designed and independently tested to withstand high elevation snow loads. To achieve the following ratings, these steel frame tables must be equipped with our V-Type Expanded Steel or H-Type Perforated Steel top and seat structures. Standard and Accessible Tables are available.

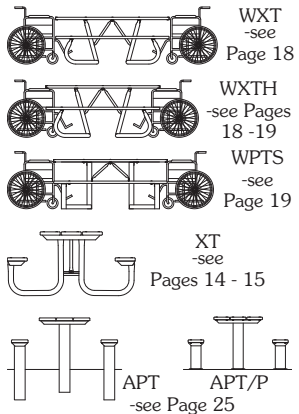

Powder Coated Frames, Black standard */(CB)		Hot-Dip Galvanized Frames (/G)		Tables Rated 1420 Lbs. Per Square Foot		
Model No.	Model No.	Length (ft.)	Material	Wt. (lbs.)	Price	
WXT/CB-6VW	WXT/G-6VW	6	*Brown V-Type Thermo-plastic Coated Expanded Steel	249	\$1,442.00	
WXT/CB-8VW	WXT/G-8VW	8		291	\$1,683.00	
WXT/CB-6HW	WXT/G-6HW	6	*Brown H-Type Thermo-plastic Coated Perforated Steel	259	\$1,468.00	
WXT/CB-8HW	WXT/G-8HW	8		305	\$1,757.00	
WXTH/CB-6VW	WXTH/G-6VW	6	*Brown V-Type Thermo-plastic Coated Expanded Steel	267	\$1,511.00	
WXTH/CB-8VW	WXTH/G-8VW	8		309	\$1,752.00	
WXTH/CB-6HW	WXTH/G-6HW	6	*Brown H-Type Thermo-plastic Coated Perforated Steel	277	\$1,537.00	
WXTH/CB-8HW	WXTH/G-8HW	8		323	\$1,826.00	
WPTS/CB-6VW	WPTS/G-6VW	6	*Brown V-Type Thermo-plastic Coated Expanded Steel	295	\$1,605.00	
WPTS/CB-8VW	WPTS/G-8VW	8		337	\$1,847.00	
WPTS/CB-6HW	WPTS/G-6HW	6	*Brown H-Type Thermo-plastic Coated Perforated Steel	305	\$1,632.00	
WPTS/CB-8HW	WPTS/G-8HW	8		351	\$1,922.00	
XT/CB-6VW	XT/G-6VW	6	*Brown V-Type Thermo-plastic Coated Expanded Steel	249	\$1,326.00	
XT/CB-8VW	XT/G-8VW	8		291	\$1,567.00	
XT/CB-10VW	XT/G-10VW	10		388	\$2,106.00	
XT/CB-6HW	XT/G-6HW	6	*Brown H-Type Thermo-plastic Coated Perforated Steel	259	\$1,344.00	
XT/CB-8HW	XT/G-8HW	8		305	\$1,639.00	
XT/CB-10HW	XT/G-10HW	10		404	\$2,279.00	
APT/CB-6VW	APT/G-6VW	6	*Brown V-Type Thermo-plastic Coated Expanded Steel	297	\$1,549.00	
APT/CB-8VW	APT/G-8VW	8		337	\$1,791.00	
APT/P/CB-6VW	APT/P/G-6VW	6		297	\$1,549.00	
APT/P/CB-8VW	APT/P/G-8VW	8		337	\$1,791.00	
APT/CB-6HW	APT/G-6HW	6	*Brown H-Type Thermo-plastic Coated Perforated Steel	307	\$1,575.00	
APT/CB-8HW	APT/G-8HW	8		351	\$1,866.00	
APT/P/CB-6HW	APT/P/G-6HW	6		307	\$1,575.00	
APT/P/CB-8HW	APT/P/G-8HW	8		351	\$1,866.00	

APT Utility Tables with the same Snow Load Rating as the APT table models above are listed on Page 43.

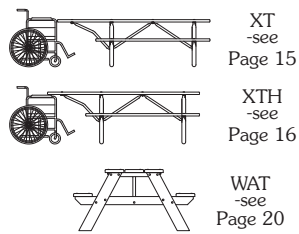

Tables Rated 948 Lbs. Per Square Foot						
Model No.	Model No.	Length (ft.)	Material	Wt. (lbs.)	Price	
XT/CB-6VW/E	XT/G-6VW/E	Top 8, Seats 6	*Brown V-Type Expanded Steel	282	\$1,536.00	
XT/CB-6HW/E	XT/G-6HW/E	Top 8, Seats 6	*Brown H-Type Perforated Steel	292	\$1,568.00	
XTH/CB-6VW/E	XTH/G-6VW/E	Top 8, Seats 6	*Brown V-Type Expanded Steel	290	\$1,577.00	
XTH/CB-6HW/E	XTH/G-6HW/E	Top 8, Seats 6	*Brown H-Type Perforated Steel	300	\$1,609.00	

Table Rated 500 Lbs. Per Square Foot				
Model No.	Length (ft.)	Material	Wt. (lbs.)	Price
WAT/W-8PC	8	*Recycled Plastic: Brown Frames and 2" x 10" Cedar colored Planks	430	\$1,620.00

TABLE FRAMES ONLY			Price are for both Hot-Dip Galvanized and Powder Coat finished models.	
Model No.	Length (ft.)	Use with	Wt. (lbs.)	Price
UT-6FR	6	Lumber, Aluminum,	76	\$307.00
UT-8FR	8	Expanded Steel,	78	\$307.00
UT-10FR	10	Perforated Steel,	114	\$461.00
UT-12FR	12	Formed Steel Channel	117	\$461.00
UT-6FRP	6	Recycled Plastic	114	\$413.00
UT-8FRP	8		127	\$429.00
UT-10FRP	10		127	\$614.00
XT-6FR	6	Lumber, Aluminum,	103	\$394.00
XT-8FR	8	Expanded Steel,	105	\$394.00
XT-10FR	10	Perforated Steel,	155	\$591.00
XT-12FR	12	Formed Steel Channel	158	\$591.00
XT-6FRP	6	Recycled Plastic	141	\$500.00
XT-8FRP	8		154	\$516.00
XT-10FRP	10		160	\$788.00

TABLE FRAMES ONLY ... continued			Prices are for both Hot-Dip Galvanized and Powder Coat finished models.	
Model No.	Length (ft.)	Use with	Wt. (lbs.)	Price
UT-6FR/E	8	Lumber, Aluminum, Expanded Steel, Perforated Steel, Formed Steel Channel	83	\$343.00
UT-6FR/EE	10	Lumber, Aluminum	90	\$379.00
UT-8FR/E	10		85	\$343.00
UT-6FRP/E	8	Recycled Plastic	127	\$449.00
UT-8FRP/E	10		127	\$465.00
XT-6FR/E	8	Lumber, Aluminum, Expanded Steel, Perforated Steel, Formed Steel Channel	110	\$430.00
XT-6FR/EE	10	Lumber, Aluminum	117	\$466.00
XT-8FR/E	10		112	\$430.00
XT-6FRP/E	8	Recycled Plastic	154	\$536.00
XT-8FRP/E	10		154	\$552.00

TABLE FRAMES ONLY ... continued on Page 30

*See Pages 57 - 59 for optional lumber species, material color options, and the character designators to specify those options in the Model Numbers.

TABLE FRAMES ONLY ... continued			Prices are for both Hot-Dip Galvanized and Powder Coat finished models.	
Frame only Kits include frame units, all fasteners and related hardware, and diagonal braces for portable tables.				
Model No.	Length (ft.)	Use with	Wt. (lbs.)	Price
UTH-6FR/E	8	Lumber, Aluminum, Expanded Steel, Perforated Steel, Formed Steel Channel	87	\$386.00
UTH-6FR/EE	10	Lumber, Aluminum	92	\$422.00
UTH-8FR/E	10		89	\$386.00
UTH-6FRP/E	8	Recycled Plastic	131	\$492.00
UTH-8FRP/E	10		131	\$508.00
UTH-6FR	6	Lumber, Aluminum, Expanded Steel, Perforated Steel, Formed Steel Channel	81	\$350.00
UTH-8FR	8	Recycled Plastic	83	\$350.00
UTH-6FRP	6		119	\$456.00
UTH-8FRP	8	132	\$472.00	
XTH-6FR/E	8	Lumber, Aluminum, Expanded Steel, Perforated Steel, Formed Steel Channel	118	\$471.00
XTH-6FR/EE	10	Lumber, Aluminum	125	\$507.00
XTH-8FR/E	10		120	\$471.00
XTH-6FRP/E	8	Recycled Plastic	162	\$577.00
XTH-8FRP/E	10		162	\$629.00
XTH-6FR	6	Lumber, Aluminum, Expanded Steel, Perforated Steel, Formed Steel Channel	114	\$435.00
XTH-8FR	8	Recycled Plastic	116	\$435.00
XTH-6FRP	6		152	\$541.00
XTH-8FRP	8	165	\$556.00	
UT-6FR/SA	6	Lumber, Aluminum	88	\$337.00
UT-8FR/SA	8		90	\$337.00
UT-10FR/SA	10		126	\$506.00
UT-12FR/SA	12		129	\$506.00
UT-6FRP/SA	6	Recycled Plastic	115	\$443.00
UT-8FRP/SA	8		125	\$459.00
XT-6FR/SA	6	Lumber, Aluminum	115	\$424.00
XT-8FR/SA	8		117	\$424.00
XT-10FR/SA	10		167	\$621.00
XT-12FR/SA	12		170	\$621.00
XT-6FRP/SA	6	Recycled Plastic	142	\$530.00
XT-8FRP/SA	8		152	\$546.00
XT4-10FRP/SA	10, 4 Frames		255	\$910.00
UTK-4FR	4	Lumber, Aluminum, Expanded Steel, Perforated Steel, Formed Steel Channel	53	\$235.00
UTK-6FR	6	Recycled Plastic	54	\$235.00
UTK-8FR	8		56	\$235.00
UTK-4FRP	4	Recycled Plastic	53	\$235.00
UTK-6FRP	6		92	\$341.00
UTK-8FRP	8		105	\$357.00
SQTK-4FR	48" Square Top	Lumber, Aluminum, Recycled Plastic, Expanded Steel, Perforated Steel	60	\$334.00
T104K-4FR	48" Diameter Round Top	Recycled Plastic, Expanded Steel, Perforated Steel		\$380.00
WXT-6FR	6	Lumber, Aluminum, Expanded Steel, Perforated Steel, Formed Steel Channel	103	\$509.00
WXT-8FR	8		105	\$509.00
WXT-10FR	10		155	\$706.00
WXT-12FR	12	Recycled Plastic	158	\$706.00
WXT-6FRP	6		141	\$615.00
WXT-8FRP	8	154	\$631.00	
WXTH-6FR	6	Lumber, Aluminum, Expanded Steel, Perforated Steel, Formed Steel Channel	121	\$578.00
WXTH-8FR	8		123	\$578.00
WXTH-10FR	10		166	\$796.00
WXTH-12FR	12		169	\$796.00
WXTH-6FRP	6	Recycled Plastic	159	\$721.00
WXTH-8FRP	8		172	\$737.00

TABLE FRAMES ONLY ... continued			Prices are for both Hot-Dip Galvanized and Powder Coat finished models.	
Frame only Kits include frame units, all fasteners and related hardware, and diagonal braces for portable tables.				
Model No.	Length (ft.)	Use with	Wt. (lbs.)	Price
WPTS-6FR	6	Lumber, Aluminum, Expanded Steel, Perforated Steel, Formed Steel Channel	149	\$672.00
WPTS-8FR	8		151	\$672.00
WPTS-6FRP	6	Recycled Plastic	187	\$778.00
WPTS-8FRP	8		200	\$794.00
T720-6FR	6	Lumber, Aluminum, Expanded Steel, Perforated Steel, Formed Steel Channel	125	\$562.00
T720-8FR	8	Recycled Plastic	126	\$562.00
T720-6FRP	6		163	\$668.00
T720-8FRP	8	175	\$684.00	
T720-6FR/E1	8	Lumber, Aluminum, Expanded Steel, Perforated Steel, Formed Steel Channel	125	\$562.00
T720-6FRP/E1	8	Recycled Plastic	176	\$714.00
BTUG-4FR	4	Lumber, Aluminum	60	\$299.00
BTUG-6FR	6		60	\$299.00
BTUG-8FR	8		60	\$299.00
BTXG-6FR	6		80	\$345.00
BTXG-8FR	8	80	\$345.00	
SQT-3FR	38" Sq. Top	Lumber, Aluminum, Recycled Plastic, Expanded Steel, Perforated Steel	76	\$380.00
SQT-4FR	48" Sq. Top	Lumber, Aluminum, Recycled Plastic, Expanded Steel, Perforated Steel	80	\$380.00
SQT-3FR/B	38" Sq. Top, Backrests		108	\$545.00
SQT-4FR/B	48" Sq. Top, Backrests	Expanded Steel, Perforated Steel	112	\$545.00
SQTB-4FRV	48" Sq. Top, Bench Seats		Order SQT-4FR Frames -see above	
SQT3-4FR/E	48" Extended Top	Lumber, Recycled Plastic, Expanded Steel, Perforated Steel	70	\$410.00
SQT3B-4FRV/E	Extended Top, Bench Seats	Expanded Steel, Perforated Steel	Order SQT3-4FR/E Frames -see above	
PQT-3FR	38" Sq. Top	Lumber, Aluminum, Recycled Plastic, Expanded Steel, Perforated Steel	154	\$764.00
PQT/P-3FR	38" Sq. Top		167	\$764.00
PQT-4FR	48" Sq. Top	Lumber, Aluminum, Recycled Plastic, Expanded Steel, Perforated Steel	182	\$839.00
PQT/P-4FR	48" Sq. Top		195	\$839.00
PQTB-4FRV	48" Sq. Top, Bench Seats	Expanded Steel, Perforated Steel	Order PQT-4FR Frames -see above	
PQTB/P-4FRV	48" Sq. Top, Bench Seats		Order PQT/P-4FR Frames -see above	
PQT3-4FR	48" Sq. Top, 3 Seats	Lumber, Aluminum, Recycled Plastic, Expanded Steel, Perforated Steel	157	\$719.00
PQT3/P-4FR	48" Sq. Top, 3 Seats		170	\$719.00
PQT3B-4FRV	48" Sq. Top, 3 Bench Seats	Expanded Steel, Perforated Steel	Order PQT3-4FR Frames -see above	
PQT3B/P-4FRV	48" Sq. Top, 3 Bench Seats		Order PQT3/P-4FR Frames -see above	
T104-4FR	48" Round Top Curved Seats	Recycled Plastic, Expanded Steel, Perforated Steel, Cut Steel Plate	Order SQT-4FR Frames -see above	
T134-4FR	48" Round Top Bench Seats	Expanded Steel, Perforated Steel, Cut Steel Plate		

TABLE FRAMES ONLY ... continued on Page 31

*See Pages 57 – 59 for optional lumber species, material color options, and the character designators to specify those options in the Model Numbers.

RJ Thomas Mfg. Co., Inc.

P.O. Box 946 • Cherokee, Iowa 51012-0946 • ORDERS Toll Free: 800-762-5002 • FAX: 712-225-5796 • 712-225-5115

TABLE FRAMES ONLY ... continued			Prices are for both Hot-Dip Galvanized and Powder Coat finished models.	
Frame only Kits include frame units, all fasteners and related hardware, and diagonal braces for portable tables.				
Model No.	Length (ft.)	Use with	Wt. (lbs.)	Price
T204-4FR	48" Round Top Curved Seats	Expanded Steel, Perforated Steel, Cut Steel Plate	110	\$400.00
T214-4FR	48" Round Top Round Seats	Recycled Plastic, Expanded Steel, Perforated Steel, Cut Steel Plate	110	\$400.00
T214-4FRP	48" Round Top Round Seats	Recycled Plastic	130	\$400.00
T224-4FR	48" Round Top Chair Seats	Expanded Steel, Perforated Steel	110	\$400.00
T304-4FR	48" Round Top (4) Curved Seats	Recycled Plastic, Expanded Steel, Perforated Steel, Cut Steel Plate	182	\$839.00
T303-4FR	48" Round Top (3) Curved Seats	Recycled Plastic, Expanded Steel, Perforated Steel, Cut Steel Plate	157	\$719.00
T334-4FR	48" Round Top (4) Bench Seats	Expanded Steel, Perforated Steel	182	\$839.00
T333-4FR	48" Round Top (3) Bench Seats	Expanded Steel, Perforated Steel	157	\$719.00
T404-4FR	48" Round Top (4) Curved Seats	Recycled Plastic, Expanded Steel, Perforated Steel, Cut Steel Plate	195	\$839.00
T403-4FR	48" Round Top (3) Curved Seats	Recycled Plastic, Expanded Steel, Perforated Steel, Cut Steel Plate	170	\$719.00
T434-4FR	48" Round Top (4) Bench Seats	Expanded Steel, Perforated Steel	195	\$839.00
T433-4FR	48" Round Top (3) Bench Seats	Expanded Steel, Perforated Steel	170	\$719.00
APT-6FR	6	Lumber, Aluminum, Expanded Steel, Perforated Steel, Formed Steel Channel	151	\$615.00
APT/P-6FR	6	Recycled Plastic	151	\$615.00
APT-6FRP	6	Recycled Plastic	189	\$721.00
APT/P-6FRP	6		189	\$721.00
APT-8FR	8	Lumber, Aluminum, Expanded Steel, Perforated Steel, Formed Steel Channel	151	\$615.00
APT/P-8FR	8	Recycled Plastic	151	\$615.00
APT-8FRP	8	Recycled Plastic	200	\$737.00
APT/P-8FRP	8		200	\$737.00

TABLE FRAMES ONLY ... continued			Prices are for both Hot-Dip Galvanized and Powder Coat finished models.	
Frame only Kits include frame units, all fasteners and related hardware, and diagonal braces for portable tables.				
Model No.	Length (ft.)	Use with	Wt. (lbs.)	Price
APT-6FR/E1	8	Lumber, Aluminum, Expanded Steel, Perforated Steel, Formed Steel Channel	151	\$615.00
APT/P-6FR/E1	8	Recycled Plastic	151	\$615.00
APT-6FRP/E1	8	Recycled Plastic	200	\$721.00
APT/P-6FRP/E1	8		200	\$721.00
APT-6FRP34	6	3" x 4" Recycled Plastic Timbers	189	\$737.00
APT/P-6FRP34	6		189	\$737.00
APT-8FRP34	8		200	\$760.00
APT/P-8FRP34	8		200	\$760.00
APT-6FRP34/E1	8		200	\$721.00
APT/P-6FRP34/E1	8		200	\$721.00
TPT-6FR	6	Lumber, Aluminum, Expanded Steel, Perforated Steel, Formed Steel Channel	112	\$548.00
TPT-8FR	8		112	
TPT-10FR	10		168	\$822.00
TPT-6FRP	6	Recycled Plastic	150	\$654.00
TPT-8FRP	8		161	\$670.00
TPT/P-6FR	6	Lumber, Aluminum, Expanded Steel, Perforated Steel, Formed Steel Channel	126	\$548.00
TPT/P-8FR	8		189	\$822.00
TPT/P-10FR	10		164	\$654.00
TPT/P-6FRP	6	Recycled Plastic	164	\$654.00
TPT/P-8FRP	8		175	\$670.00
TPT-6FR/E	8	Lumber, Aluminum, Expanded Steel, Perforated Steel, Formed Steel Channel	117	\$578.00
TPT-6FRP/E	8	Recycled Plastic	161	\$684.00
TPT/P-6FR/E	8	Lumber, Aluminum, Expanded Steel, Perforated Steel, Formed Steel Channel	131	\$578.00
TPT/P-6FRP/E	8	Recycled Plastic	175	\$684.00
PT-6FR	6	Lumber, Aluminum, Recycled Plastic, Expanded Steel, Perforated Steel, Formed Steel Channel	145	\$688.00
PT/P-6FR	6		158	\$688.00

*See Pages 57 – 59 for optional lumber species, material color options, and the character designators to specify those options in the Model Numbers.

ACCESSORIES for TABLES

UMBRELLAS (Catalog Page 48) Available for Square and Round Tables only.

MODEL UM-4 PREMIUM ACRYLIC UMBRELLA				7-1/2 ft. dia., Garden Style, 9 oz. marine grade Acrylic Fabric, crank lift, 3-position tilt mechanism.			
Model No.	Solid Color	Wt. (lbs.)	Price	Model No.	Alternating Colors	Wt. (lbs.)	Price
UM-4/PBLU	Pacific Blue	13	\$330.00	UM-4/PBLU-WHIT	Pacific Blue/White	13	\$330.00
UM-4/FGRN	Forest Green			UM-4/FGRN-WHIT	Forest Green/White		
UM-4/LRED	Logo Red			UM-4/LRED-WHIT	Logo Red/White		
UM-4/SYEL	Sunflower Yellow			UM-4/BEACH	Beachball (red, yellow, blue, bright green)		

MODEL UM-5 ECONOMY VINYL UMBRELLA				7-1/2 ft. dia., Garden Style, 13 oz. Vinyl, crank lift, 3-position tilt mechanism.			
Model No.	Solid Color	Wt. (lbs.)	Price	Model No.	Alternating Colors	Wt. (lbs.)	Price
UM-5/WHIT	White	15	\$251.00			15	\$251.00
UM-5/FGRN	Forest Green			UM-5/FGRN-WHIT	Forest Green/White		
UM-5/BLU	Blue			UM-5/BLU-WHIT	Blue/White		
UM-5/RED	Red			UM-5/RED-WHIT	Red/White		
UM-5/NBLU	Navy Blue			UM-5/NBLU-WHIT	Navy Blue/White		
UM-5/KGRN	Kelly Green			UM-5/KGRN-WHIT	Kelly Green/White		
UM-5/YEL	Yellow			UM-5/YEL-WHIT	Yellow/White		

MODEL UM-11 PREMIUM ACRYLIC UMBRELLA				9 ft. dia., Market Style, 9 oz. marine grade Acrylic Fabric, commercial pulley, no tilt mechanism.			
Model No.	Solid Color	Wt. (lbs.)	Price	Model No.	Solid Color	Wt. (lbs.)	Price
UM-11/PBLU	Pacific Blue	21	\$561.00	UM-11/TOAST	Toast	21	\$561.00
UM-11/FGRN	Forest Green		\$561.00	UM-11/LRED	Logo Red		\$588.00
UM-11/NBLU	Navy Blue		\$561.00	UM-11/WHIT	White		\$561.00

Other solid colors and alternating colors may be available. Please inquire.

UMBRELLA CUP & COLLAR SETS (Catalog Pages 38 & 39)

When ordering a Square Table with an Umbrella with Lumber, Aluminum, or Recycled Plastic table tops, a mounting hole in the table top must be specified. Square and Round Tables with Thermo-plastic coated Expanded Steel, Perforated Steel, or Cut Steel Plate table tops are Umbrella ready with built-in holes and the appropriate hardware included.

Model No.	Description	Price
NA	Optional Umbrella Mounting Hole ordered in the table top on Portable or Pedestal Square Tables with Lumber or Recycled Plastic (appropriate Cup and Collar Set included)	Add "/U" to the end of the Table Model No. and add to Table Price: \$24.00
NA	Optional Umbrella Mounting Hole ordered in the table top on Portable or Pedestal Square Tables with Aluminum (appropriate Cup and Collar Set included)	Add "/U" to the end of the Table Model No. and add to Table Price: \$36.00
UM-CC/SQ	Cup and Collar Set for Portable Square Tables. Ordered separately from table.	\$24.00
UM-CC/PQ	Cup and Collar Set for Pedestal Square Tables. Ordered separately from table.	\$24.00

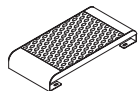

HEAT SHIELD for PICNIC TABLE TOPS (Catalog Page 49)			
Model No.	Description	Wt. (lbs.)	Price
HS-TB/G	Expanded Steel surface, steel frame. Approximately 12" deep x 25-1/2" wide x 3-1/2" tall. Includes fasteners. Hot-Dip Galvanized	12	\$64.00

TABLE TOP END CAPS (Catalog Page 49)

Model No.	Size/Description	Wt. (lbs.)	Price
TAK-21G	Table Top Alignment Kit for 2" x 10" Lumber: (2) formed, 28" long pregalvanized steel Channels and Wood Screws	4	\$21.00
TAK-31G	Table Top Alignment Kit for 3" x 10" Lumber: (2) formed, 28" long pregalvanized steel Channels and Wood Screws	5	\$26.00

BACKRESTS (Catalog Page 49)

Backrest Brackets: (1) pair/seat, sold in sets for (2) seats (4 Brackets). Available on 6 ft. and 8 ft. UT, XT, UTH, and XTH portable rectangular tables with Lumber only. Available on 3 ft. and 4 ft. SQT Portable Square Tables with all materials.			
Model No.	Description	Wt. (lbs.)	Price
BRB/▼-FR	(1) Set for (2) Seats (4 Backrest Brackets)	23	\$66.00
Replace ▼ in the Model No. with G for Hot-Dip Galvanized finish or for *Powder Coated finish colors to match table frames use the letter designations on Page 57.			

*See Pages 57 – 59 for optional lumber species, material color options, and the character designators to specify those options in the Model Numbers.

TABLE SIGNAGE (Catalog Pages 24, 25, & 50)		
Signage Option	Description	Price
ENGRAVED and RESIN FILLED LETTERS	Custom engraved lettering on Recycled Plastic table top planks up to a maximum height of 3" per letter (for larger letters, please inquire). May be filled with colored resin. A drawing of the layout will be provided for approval.	
	Set-up Charge per unique line of text on a board (if text changes another charge applies)	\$35.00
	Cost per 3" Routed Letter, in addition to the initial Set-up Charge (for larger letters, please inquire)	\$6.00
	Cost per 3" Routed Letter with Colored Resin Fill, in addition to the initial Set-up Charge (for larger letters, please inquire)	\$12.00
LAMINATE PLAQUES	Plaques of laminated impact acrylic, 3 ply thick (1/8"). Standard size plaque is 2-1/2" high x 11-3/4" wide to fit most table applications (for larger sizes, please inquire). Artwork for the design will be provided for approval.	
	Surface and core color combinations include, but are not limited to (surface/core): Black/Gold, Black/White, or Beige/Chocolate Brown. Other color combinations may be available, please inquire.	
	Model No.: PLAQUE-1 -Text only, Standard size 2-1/2" high x 11-3/4" wide	\$86.00
	Model No.: PLAQUE-1LG -Text with Laser Engraved Graphics, Standard size 2-1/2" high x 11-3/4" wide	\$131.00
PERFORATED STEEL SIGNAGE	Model No.: LETTERS-2 -Custom lettering incorporated into the Table Top and Thermo-plastic coated in specified color (number and size of letters is limited). A drawing of the layout will be provided for approval. Price is for each order for each distinct message on a specific Model of Table.	\$255.00

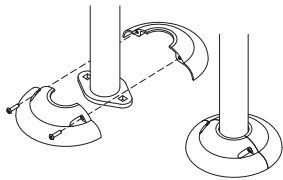

COVER CAPS (Catalog Page 50)			
Cover Caps fit on T600 Series Caterpillar Tables and FCT Series Food Court Tables . Refer to Page 13 in the Benches section for detailed information on the Cover Caps.			
Model No.	Description	Wt. (lbs.)	Price
CC-1	1 Cover Cap (2 Halves), no coating, with fasteners	1	\$37.00
CC/CB-1	1 Cover Cap (2 Halves), *Powder Coated Black Finish (/CB), with fasteners		

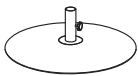

UMBRELLA BASE (Catalog Page 50)			
Designed to hold the end of an umbrella pole under the table with the umbrella pole inserted through a hole in the table top to keep the umbrella vertical and secure. NOT designed to hold an umbrella alone -the umbrella pole must be inserted through a hole in the table top.			
Model No.	Description	Wt. (lbs.)	Price
UMB/B-1	23-3/8" dia. steel Disc Base with 1-5/8" I.D. (1.90" O.D.) x 6" long steel Receiving Pipe finished in Black Enamel, thumb Set Screw with Knob, and assembly hardware	20	\$124.00

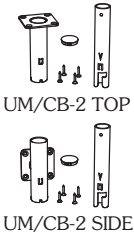

PATIO BUDDY UMBRELLA MOUNT			
Removable Umbrella Mount for lumber picnic tables, decks, or docks. Fits 1-5/16" to 1-1/2" dia. poles. Revolutionary twist-lock mechanism to lock umbrella in place. Black powder coat finish. Stainless steel twist-lock components.			
Model No.	Description	Wt. (lbs.)	Price
UM/CB-2 TOP	Top Mount unit, Umbrella Pole Adapter unit, Plastic Cap for the mount, and Wood Screws	5	\$119.00
UM/CB-2 TOP/MNT	Top Mount unit only, Plastic Cap for the mount, and Wood Screws	3	\$80.00
UM/CB-2 SIDE	Side Mount unit, Umbrella Pole Adapter unit, Plastic Cap for the mount, and Wood Screws	5	\$119.00
UM/CB-2 SIDE/MNT	Side Mount unit only, Plastic Cap for the mount unit, and Wood Screws	3	\$80.00
222-110-CB	Umbrella Pole Adapter unit only	2	\$60.00

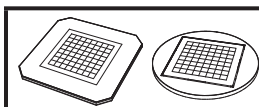

GAME BOARD TABLE TOPS (Catalog Pages 38, 39, 41, & 50)			
Available to replace standard Table Tops for 48" Square or Round Tables with Thermo-plastic coated Expanded or Perforated Steel. 14 ga. steel insert Powder Coated in Black. Red and black Checkerboard vinyl decal is clear coat sealed after application to the insert. -Add /GT to the regular table Model Numbers.			
Available on these Table Series	Size 48", Style	Table Top Material	Add to complete Table Price
SQT-4, SQTB-4, SQTk-4	Portable Square	Thermo-plastic coated V-Type Expanded Steel (VW) or H-Type Perforated Steel (HW)	\$324.00
PQT-4, PQT/P-4, PQT3-4, PQT3/P-4, PQTb-4, PQTb/P-4	Pedestal Square		
T100, T104K, T200, T300, T400	Round	Thermo-plastic coated D-Type Expanded Steel (DW) or R-Type Perforated Steel (RW)	

*See Pages 57 – 59 for optional lumber species, material color options, and the character designators to specify those options in the Model Numbers.

WASTE AND RECYCLING PRODUCTS

CERTIFIED BEAR RESISTANT TRASH RECEPTACLES (Catalog Page 58) 

All welded heavy steel construction, 14 gauge formed steel with 7 gauge reinforcing and base, 16" square 12 gauge hinged Hatches, stainless steel Hatch and Door hinges; tight fitting Hatches and front access Doors are self-latching with covered Latches to keep bears out; interior Rain Gutter to drain away infiltrating moisture; textured Powder Coated finish; includes choice of Decal for top Hatches, 36 gal. heavy duty rigid Plastic Liners, concrete Anchor Kits

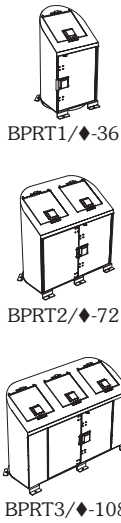

Model No.	IGBC Certification Number	Top Hatches	Liners included	Collect	Optional Recycling Plate available	Decal Choices - please specify	Anchor Kit included	Wt. (lbs.)	Price
BPRT1/◆-36	5106	1	1	Trash & Recyclables	1	DE-1, DE-2, DE-3, DE-4, DE-5, DE-11, DE-19	ANC5-4	165	\$1,199.00
BPRT2/◆-72	5124	2	2		1 or 2		ANC5-6	308	\$1,822.00
BPRT3/◆-108	5107	3	3		1, 2, or 3		ANC5-6	386	\$2,126.00

Replace ◆ in Model No. with CWT for Brown, CNT for Green, CBT for Black, CUT for Blue, or CTT for Speckled Tan textured Powder Coated finish.

Model No.	Size/Description	Wt. (lbs.)	Price
BPRP/CB-PC1	Optional steel Recycling Plate Insert: 3" dia. Hole for recycling, Powder Coated Black	6	\$66.00
BPRP/CB-PC5	Optional steel Recycling Plate Insert: 4-3/8" dia. Hole for recycling, Powder Coated Black	6	\$66.00
BPRP/CB-PC6	Optional steel Recycling Plate Insert: 5-7/8" dia. Hole for recycling, Powder Coated Black	6	\$66.00
DE-1	"CANS ONLY" Recycling Decal, Green Lettering and Recycling Symbol on adhesive backed, White Vinyl Plastic		\$12.00
DE-2	"PAPER ONLY" Recycling Decal, Green Lettering and Recycling Symbol on adhesive backed, White Vinyl Plastic		\$12.00
DE-3	"PLASTIC ONLY" Recycling Decal, Green Lettering and Recycling Symbol on adhesive backed, White Vinyl Plastic		\$12.00
DE-4	"GLASS ONLY" Recycling Decal, Green Lettering and Recycling Symbol on adhesive backed, White Vinyl Plastic		\$12.00
DE-5	"ALUMINUM ONLY" Recycling Decal, Green Lettering and Recycling Symbol on adhesive backed, White Vinyl Plastic		\$12.00
DE-11	"TRASH ONLY" Decal, Green Lettering on adhesive backed, White Vinyl Plastic		\$12.00
DE-19	"RECYCLE ONLY" Recycling Decal, Green Lettering and Recycling Symbol on adhesive backed, White Vinyl Plastic		\$12.00
PL-1	Padlock: Precision Brass Tumbler and Case, keyed alike, 2-1/2" overall		\$12.00

VARMINT DEFIANT TRASH CAN COVER (Catalog Page 59) 

Heavy gauge welded steel construction mounted on 3-1/2" O.D. x 1/8" wall steel Post, includes Decal Set, Brass Padlock - fits 30 to 32 gal. steel Trash Cans (Model CNG-WHD32C Federal Duty Trash Can recommended - not included)

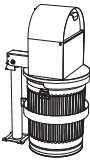

Model No.	Description	Wt. (lbs.)	Price
CN-VDT/CW-32	*Brown Powder Coated Cover, long post for concrete embedment	89	\$606.00
CN-VDT/P/CW-32	*Brown Powder Coated Cover, base plate post for surface mount, concrete anchors included		\$621.00

For other *Powder Coated finish colors replace /CW in the Model Nos. with the letter designations on Page 57.

PARK POLICEMAN - Expanded Steel (Catalog Page 59) 



Model No.	Size/Description	Wt. (lbs.)	Price
CN/G-EXP52	48 Gal. Expanded Steel Receptacle, Hot-Dip Galvanized, 23-1/2" top O.D. x 19-1/2" bottom O.D., 33" tall	31	\$374.00
CN/TN-EXP52	48 Gal. Expanded Steel Receptacle, *Green Thermo-plastic Coated, 23-1/2" top O.D. x 19-1/2" bottom O.D., 33" tall		

ROUND RECEPTACLE - Vertical Steel Strap (Catalog Page 60) 



Welded single unit construction with 1/8" x 2" steel straps, (4) adjustable levelers

Model No.	Size/Description	Wt. (lbs.)	Price
CN-R/SS2/CU-36	30-36 Gal. *Blue Powder Coated Steel Strap Receptacle	75	\$606.00

ROUND RECEPTACLE - Perforated Steel (Catalog Page 60) 14 ga. Perforated Steel body, 10 ga. Steel top and bottom rings and braces



Model No.	Size/Description 	Optional Liner	Wt. (lbs.)	Price
CN-R/RW-32	30-36 Gal. *Brown Thermo-plastic Coated Receptacle, 23-1/4" O.D. x 29-3/4" tall	CN/B-1827	46	\$426.00
CN-R/RW-52	52 Gal. *Brown Thermo-plastic Coated Receptacle, 26-1/2" O.D. x 29-3/4" tall	CN/B-1828	51	\$476.00
CN-R/RW-55	55 Gal. *Brown Thermo-plastic Coated Receptacle, 26-1/2" O.D. x 36" tall	CN/B-1829	60	\$518.00

Replace /RW in Model No. with /R/G for Hot-Dip Galvanized finish for all 3 sizes of receptacles.

ROUND RECEPTACLE - Expanded Steel (Catalog Page 61) 3/4-#9 Expanded Steel body, 10 ga. Steel top and bottom rings and braces



Model No.	Size/Description 	Optional Liner	Wt. (lbs.)	Price
CN-R/DW-32	30-36 Gal. *Brown Thermo-plastic Coated Receptacle, 23-1/4" O.D. x 29-3/4" tall	CN/B-1827	44	\$338.00
CN-R/DW-52	52 Gal. *Brown Thermo-plastic Coated Receptacle, 26-1/2" O.D. x 29-3/4" tall	CN/B-1828	49	\$364.00
CN-R/DW-55	55 Gal. *Brown Thermo-plastic Coated Receptacle, 26-1/2" O.D. x 36" tall	CN/B-1829	56	\$399.00

*See Pages 57 - 59 for optional lumber species, material color options, and the character designators to specify those options in the Model Numbers.



ROUND RECEPTACLE - Cut Steel Plate (Catalog Page 61) ♿			
Model No.	Size/Description	Wt. (lbs.)	Price
CN-R/SP2/TN-32	30-36 Gal. *Green Thermo-plastic Coated Steel Receptacle	57	\$696.00



ROUND STEEL RECEPTACLE with RAIN BONNET and LOCKABLE DOOR (Catalog Page 62) ♿			
Welded single unit construction of 3/16" thick, laser cut steel sheet with welded-on Rain Bonnet; keyed, lockable Side Open Door; adjustable Levelers			
Model No.	Size/Description	Wt. (lbs.)	Price
CN-R/SP3/CB-36D	30-36 Gal. *Black Powder Coated Steel Receptacle	101	\$852.00



ROUND RECEPTACLE with DOOR - Vertical Steel Strap (Catalog Page 62) ♿			
Welded single unit construction with 1/8" x 2" steel straps and Side Open Door, (4) adjustable levelers			
Model No.	Size/Description	Wt. (lbs.)	Price
CN-R/SS2/CB-36D	30-36 Gal. *Black Powder Coated Steel Strap Receptacle	105	\$884.00



CN-AMR-32 CN-AMQ-32

AMHERST RECEPTACLES - Round AMR Series and Square AMQ Series (Catalog Page 63) ♿			
Model No.	Size/Description	Wt. (lbs.)	Price
CN-AMR/CN-32	Round Steel Receptacle, for 30-36 Gal. Cans and Liners, *Green Powder Coated	129	\$927.00
CN-AMQ/CN-32	Square Steel Receptacle, for 30-36 Gal. Cans and Liners, *Green Powder Coated	145	\$1,043.00



VERTICAL WAVE ROUND STEEL STRAP TRASH RECEPTACLE (Catalog Page 63) ♿			
Welded single unit construction with 1/8" x 1" steel straps die-formed into a wave pattern, (4) adjustable levelers, holds 30-36 gal. liners			
Model No.	Size/Description	Wt. (lbs.)	Price
CN-R/SS3/TW-36	30-36 Gal., 29" O.D. x 22-3/4" I.D. x 32" tall, *Brown Thermo-plastic Coated	67	\$675.00



TRH-32



TRH-55

TRASH and RECYCLING RECEPTACLE HOLDERS - TRH Series (Catalog Page 64) ♿										
10 ga. steel top and base rings with formed flanges, die-formed cross braces on base ring. 2" x 4" Slats in choice of Treated #1 Southern Yellow Pine or Recycled Plastic.					Treated #1 Southern Yellow Pine Slats ◆ = TP		*Cedar colored Recycled Plastic Slats ◆ = PC		Frame Kit only ◆ = FR	
Model No.	Size	Frame Finish	Wt. (lbs.)	Price	Wt. (lbs.)	Price	Wt. (lbs.)	Price	Wt. (lbs.)	Price
TRH/CB-32◆24	22-3/8" I.D. for 30-36 Gal. Can	*Black	76	\$359.00	119	\$553.00	20	\$140.00		
TRH/CB-55◆24	25-3/8" I.D. for 55 Gal. Barrel or Liner	Powder Coated	98	\$430.00	158	\$711.00	21	\$140.00		

Replace /CB in Model No. with /G for Hot-Dip Galvanized finish or for other *Powder Coated finish colors replace with letter designations on Page 57.



TRH-55

SIDE OPENING TRASH KIT - TRH Series (Catalog Page 64) ♿										
Kit includes a TG-27X Steel Flat Lid, an HHG-2 Hinge and Hasp Kit, a Brass Padlock, and a CN/B-1827 heavy duty, rigid 36 Gal. Plastic Liner, 2" x 4" Slats in choice of Treated #1 Southern Yellow Pine or Recycled Plastic.					Treated #1 Southern Yellow Pine Slats ◆ = TP		*Cedar colored Recycled Plastic Slats ◆ = PC		Frame Kit only ◆ = FR	
Model No.	Description	Wt. (lbs.)	Price	Wt. (lbs.)	Price	Wt. (lbs.)	Price	Wt. (lbs.)	Price	
TRH/CB-55◆24/SO	(1) Side Opening, *Black Powder Coated Frame	118	\$618.00	175	\$935.00	23	\$165.00			
TRH/CB-55◆24/SO2	(2) Side Openings, *Black Powder Coated Frame	118	\$618.00	175	\$935.00	23	\$165.00			

Replace /CB in Model No. with /G for Hot-Dip Galvanized finish or for other *Powder Coated finish colors replace with letter designations on Page 57.
*Powder Coated finish also available on the T-27X Steel Flat Lid - see Page 57 for color choices and letter designations to specify the selected color.

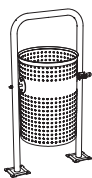

TILTING TRASH RECEPTACLE (Catalog Page 65) ♿			
52 gal. Thermo-plastic coated Perforated Steel Basket mounted on 2-3/8" O.D. Powder Coated steel pipe Frame with twin posts, commercial grade spring-loaded Latch mechanism. See Pages 36-38 for plastic or steel Trash Can Lids, Dome Lids, and Recycling Lids for use on the Receptacle.			
Model No.	Description	Wt. (lbs.)	Price
CN-TR/CW-52RW	52 gal. *Brown Receptacle and Frame, long post for concrete embedment	100	\$557.00
CN-TR/P/CW-52RW	52 gal. *Brown Receptacle and Frame, base plate for surface mount, concrete anchors included		

For custom signage cut in the solid band around the basket or adhesive vinyl decals - Please Inquire.

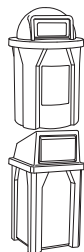

KOLORCANS TRASH RECEPTACLES (Catalog Page 65) ♿			
Round or Square receptacles of rotationally molded, heavy weight polyethylene plastic with color molded in; includes outer base, top, and inside liner			
Model No.	Size/Description	Wt. (lbs.)	Price
Round - Base and top are the same color.			
CN-S7101A/◆	42 gal., solid color, Dome Top (waste)	36	\$408.00
Square - Base and top are the same color.			
CN-S7801A/◆	32 gal., solid color, Square Top (waste)	29	\$408.00

For color selection replace ◆ in Model No. with U for Blue, N for Green, W for Brown, B for Black, R for Red, Y for Yellow, O for Orange, or H for White.

*See Pages 57 - 59 for optional lumber species, material color options, and the character designators to specify those options in the Model Numbers.



SQUARE RECEPTACLE HOLDER - TRQ Series (Catalog Page 66) ♿									
10 ga. steel top and base rings with formed flanges, die-formed cross braces on base ring. 2" x 4" Slats in listed materials.			Treated #1 Southern Yellow Pine Slats ◆ = TP		*Cedar colored Recycled Plastic Slats ◆ = PC		Frame Kit only ◆ = FR		
Model No.	Size	Frame Finish	Wt. (lbs.)	Price	Wt. (lbs.)	Price	Wt. (lbs.)	Price	
TRQ/CB-32◆24	for 30-32 Gal. Can	*Black Powder Coated	83	\$384.00	131	\$600.00	21	\$140.00	
Replace /CB in Model No. with /G for Hot-Dip Galvanized finish or for other *Powder Coated finish colors replace with letter designations on Page 57.									



SQUARE RECEPTACLE - Expanded Steel (Catalog Page 66) ♿			
Model No.	Size/Description	Wt. (lbs.)	Price
CN-Q/DR-32/2	30-36 Gal. *Red Thermo-plastic Coated Expanded Steel Receptacle, Rain Canopy	142	\$635.00



SQUARE STEEL FRAME & INLAY RECEPTACLE (Catalog Page 67) ♿			
2" x 2" x 11 ga. steel tube and steel channel welded into (4) single unit Side Panels inlay with Recycled Plastic 1" x 4" slats			
Model No.	Size/Description	Wt. (lbs.)	Price
CN-Q/CB-36PA	30-36 Gal. *Black Powder Coated Square Steel Frame Receptacle, inlay *Grey Recycled Plastic slats	215	\$1,248.00



SQUARE RECEPTACLE with DOOR - Vertical Steel Strap (Catalog Page 67) ♿			
Welded single unit construction with 1/8" x 2" steel straps and Side Open Door, (4) adjustable levelers			
Model No.	Size/Description	Wt. (lbs.)	Price
CN-Q/SS4/CB-36D	30-36 Gal. *Black Powder Coated Steel Strap Receptacle	125	\$1,053.00

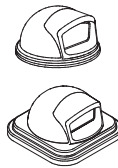

ROUND and SQUARE PILOT ROCK PLASTIC DOME LIDS (Catalog Page 68)			
Model No.	Size and Receptacles used with	Wt. (lbs.)	Price
CN-PD/◆-27	Round, 27-1/4" I.D., 27-3/4" O.D. - fits TRH-32, on top ring of TRH-55, CN-R/R-52, CN-R/D-52, CN-R/R-55, CN-R/D-55	9	\$165.00
CN-PD/◆-24	Round, 24" I.D., 24-1/2" O.D. - fits TRH-32, 55 gal. barrel inside TRH-55, CN-AMR-32, CN-R/R-32, CN-R/D-32, CN-R/SS2-36, CN-R/SS2-36D, CN-EXP52, CN-R/SP2-32, CN-TR-52, CN-R/SS3-36, RA's	8	\$170.00
CN-PQD/◆-27	Square, 27" I.D., 27-1/2" O.D. - fits TRQ-32	10	\$173.00
CN-PQD/◆-24	Square, 23-1/2" I.D., 24" O.D. - fits TRQ-32, CN-AMQ-32, CN-Q-36, CN-Q/SS4-36D	9	\$176.00
Replace ◆ in Model No. with C for Cedar, W for Brown, Y for Yellow, N for Green, A for Gray, B for Black, R for Red, U for Blue.			

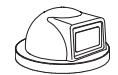

PLASTIC DOME LID - SQUARE DOOR (Catalog Page 68)			
Model No.	Size and Receptacles used with	Wt. (lbs.)	Price
CN-SDR/◆-24	24" I.D., 24-3/8" O.D. - fits TRH-32, 55 gal. barrel inside TRH-55, CN-AMR-32, CN-R/R-32, CN-R/D-32, CN-R/SS2-36, CN-R/SS2-36D, CN-EXP52, CN-R/SP2-32, CN-TR-52, CN-R/SS3-36, RA's, 55 gal. barrel	9	\$158.00
Replace ◆ in Model No. with C for Cedar, W for Brown, Y for Yellow, N for Green, A for Gray, B for Black, R for Red, U for Blue.			



STEEL DOME LIDS - Galvanized or Powder Coated Finish (Catalog Page 68) - 20 Ga. Steel			
Model No.	Size and Receptacles used with	Wt. (lbs.)	Price
CN/◆-3434	21" I.D., 21-3/4" O.D. - fits Federal Duty 32 gal. Galvanized Can CNG-WHD32C	9	\$194.00
CN/◆-5555	23-3/4" I.D., 24-1/2" O.D. - fits TRH-32, 55 gal. barrel inside TRH-55, CN-AMR-32, CN-R/R-32, CN-R/D-32, CN-R/SS2-36, CN-R/SS2-36D, CN-EXP52, CN-R/SP2-32, CN-TR-52, CN-R/SS3-36, RA's, 55 gal. barrel	11	\$205.00
CN/◆-2755	27-1/8" I.D., 27-1/4" O.D., - fits TRH-55, CN-R/R-52, CN-R/D-52, CN-R/R-55, CN-R/D-55	13	\$224.00
Replace ◆ in Model No. with G for Hot-Dip Galvanized finish or for *Powder Coated finish colors use the letter designations on Page 57.			



PLASTIC DOME LID for RECYCLING - SQUARE FACE (Catalog Page 69)				
Plastic Dome Recycling Lid, molded-in solid "door" panel with (2) vinyl trimmed hole sizes available, (1) Recycling Decal included - Please specify choice of Decal when ordering (see Page 37)				
Model No.	Hole Size	Size and Receptacles used with	Wt. (lbs.)	Price
CN-SDR/◆-24PC1	3"	24" I.D., 24-3/8" O.D. - fits TRH-32, 55 gal. barrel inside TRH-55, CN-AMR-32, CN-R/R-32, CN-R/D-32, CN-R/SS2-36, CN-R/SS2-36D, CN-EXP52,	9	\$165.00
CN-SDR/◆-24PC5	4-3/8"	CN-R/SP2-32, CN-TR-52, CN-R/SS3-36, RA's, 55 gal. barrel		
Replace ◆ in Model No. with C for Cedar, W for Brown, Y for Yellow, N for Green, A for Gray, B for Black, R for Red, U for Blue.				

*See Pages 57 - 59 for optional lumber species, material color options, and the character designators to specify those options in the Model Numbers.

PLASTIC DOME LIDS for RECYCLING – ROUND FACE (Catalog Page 69)				
Round PILOT ROCK Plastic Dome Recycling Lid, molded-in solid panel with (2) vinyl trimmed hole sizes available, (1) Recycling Decal included – Please specify choice of Decal when ordering (see below)				
Model No.	Hole Size	Size and Receptacles used with	Wt. (lbs.)	Price
CN-PD/◆-27PC1	3"	27-1/4" I.D., 27-3/4" O.D. – fits TRH-32, on top ring of TRH-55 Receptacle, CN-R/R-52, CN-R/D-52, CN-R/R-55, CN-R/D-55	9	\$165.00
CN-PD/◆-27PC5	4-3/8"			
CN-PD/◆-24PC1	3"	24" I.D., 24-1/2" O.D. – fits TRH-32, 55 gal. barrel inside TRH-55, CN-AMR-32, CN-R/R-32, CN-R/D-32, CN-R/SS2-36, CN-R/SS2-36D, CN-EXP52, CN-R/SP2-32, CN-TR-52, CN-R/SS3-36, RA's	8	\$170.00
CN-PD/◆-24PC5	4-3/8"			
Replace ◆ in Model No. with C for Cedar, W for Brown, Y for Yellow, N for Green, A for Gray, B for Black, R for Red, U for Blue.				



CN/N-3031PC5

MOLDED PLASTIC CANOPY LIDS for RECYCLING (Catalog Page 69)				
24-1/8" I.D., 24-1/2" O.D., Green Plastic Lid, molded-in solid end panels with openings on both ends, (3) vinyl-trimmed opening sizes available, (2) Recycling Decals included – Please specify choice of Decal when ordering (see below)				
– fits TRH-32, 55 gal. barrel inside TRH-55, CN-AMR-32, CN-R/R-32, CN-R/D-32, CN-R/SS2-36, CN-R/SS2-36D, CN-EXP52, CN-R/SP2-32, CN-TR-52, CN-R/SS3-36, RA's, 55 gal. barrel				
Model No.	Size/Description	Wt. (lbs.)	Price	
CN/N-3031PC1	3" vinyl-trimmed Hole in each end – for recycling aluminum cans	7	\$148.00	
CN/N-3031PC5	4-3/8" vinyl-trimmed Hole in each end – for recycling cans and bottles			
CN/N-3031PS	2" x 7-1/2" vinyl-trimmed Slot in each end – for recycling paper			

RECYCLING DECALS for DOME and CANOPY RECYCLING LIDS (Catalog Page 69)				
Printed in Recycling Green with Recycling Symbol on adhesive backed, White Vinyl Plastic. Included with Recycling Lids above and on Page 36.				
Model No.	Size/Description	Wt. (lbs.)	Price	
DE-22	"CANS ONLY" (recommended for 3" dia. hole)		\$12.00	
DE-23	"PLASTIC BOTTLES ONLY" (recommended for 4-3/8" dia. hole)			
DE-24	"CANS & BOTTLES ONLY" (recommended for 4-3/8" dia. hole)			
DE-26	"PAPER ONLY" (for use on Model CN/N-3031PS Canopy Lid only)			
DE-34	"RECYCLE ONLY" (use with any round hole size)			
Custom Decals	Same size and color. Minimum order: (15) of same design.		\$15.00	

FLAT STEEL TRASH and RECYCLING LIDS (Catalog Page 70) 16 Ga. Steel, Galvanized or optional Powder Coated finish.				
Model No.	Size and Receptacles used with	Wt. (lbs.)	Price	
Trash Can Lids – No Hole				
T◆-19X	19" I.D., 19-1/8" O.D. – fits 30 Gal. Barrel	9	\$117.00	
T◆-22X	22" I.D., 22-1/8" O.D. – fits TRH-20	10		
T◆-24X	24" I.D., 24-1/8" O.D. – fits TRH-32, 55 gal. barrel inside TRH-55, CN-AMR-32, CN-R/R-32, CN-R/D-32, CN-R/SS2-36, CN-R/SS2-36D, CN-EXP52, CN-R/SP2-32, CN-TR-52, CN-R/SS3-36, RA's, 55 gal. barrel	12		
T◆-27X	27-1/8" I.D., 27-1/4" O.D. – fits on top ring of TRH-55, CN-R/R-52, CN-R/D-52, CN-R/R-55, CN-R/D-55	12		
Trash Can Lids with 10" dia. Spring-loaded Hatch				
T◆-19	19" I.D., 19-1/8" O.D. – fits 30 Gal. Barrel	9	\$122.00	
T◆-22	22" I.D., 22-1/8" O.D. – fits TRH-20	10		
T◆-24	24" I.D., 24-1/8" O.D. – fits TRH-32, 55 gal. barrel inside TRH-55, CN-AMR-32, CN-R/R-32, CN-R/D-32, CN-R/SS2-36, CN-R/SS2-36D, CN-EXP52, CN-R/SP2-32, CN-TR-52, CN-R/SS3-36, RA's, 55 gal. barrel	12		
T◆-27	27-1/8" I.D., 27-1/4" O.D. – fits on top ring of TRH-55, CN-R/R-52, CN-R/D-52, CN-R/R-55, CN-R/D-55	12		
Recycling Lids with 3" dia. vinyl trimmed Hole				
T◆-22PC1	22" I.D., 22-1/8" O.D. – fits TRH-20	10	\$122.00	
T◆-24PC1	24" I.D., 24-1/8" O.D. – fits TRH-32, 55 gal. barrel inside TRH-55, CN-AMR-32, CN-R/R-32, CN-R/D-32, CN-R/SS2-36, CN-R/SS2-36D, CN-EXP52, CN-R/SP2-32, CN-TR-52, CN-R/SS3-36, RA's, 55 gal. barrel	12		
T◆-27PC1	27-1/8" I.D., 27-1/4" O.D. – fits on top ring of TRH-55, CN-R/R-52, CN-R/D-52, CN-R/R-55, CN-R/D-55	12		
Recycling Lids with 4-3/8" dia. vinyl trimmed Hole				
T◆-22PC5	22" I.D., 22-1/8" O.D. – fits TRH-20	10	\$122.00	
T◆-24PC5	24" I.D., 24-1/8" O.D. – fits TRH-32, 55 gal. barrel inside TRH-55, CN-AMR-32, CN-R/R-32, CN-R/D-32, CN-R/SS2-36, CN-R/SS2-36D, CN-EXP52, CN-R/SP2-32, CN-TR-52, CN-R/SS3-36, RA's, 55 gal. barrel	12		
T◆-27PC5	27-1/8" I.D., 27-1/4" O.D. – fits on top ring of TRH-55, CN-R/R-52, CN-R/D-52, CN-R/R-55, CN-R/D-55	12		
Recycling Lids with 5-7/8" dia. vinyl trimmed Hole				
T◆-22PC6	22" I.D., 22-1/8" O.D. – fits TRH-20	10	\$122.00	
T◆-24PC6	24" I.D., 24-1/8" O.D. – fits TRH-32, 55 gal. barrel inside TRH-55, CN-AMR-32, CN-R/R-32, CN-R/D-32, CN-R/SS2-36, CN-R/SS2-36D, CN-EXP52, CN-R/SP2-32, CN-TR-52, CN-R/SS3-36, RA's, 55 gal. barrel	12		
T◆-27PC6	27-1/8" I.D., 27-1/4" O.D. – fits on top ring of TRH-55, CN-R/R-52, CN-R/D-52, CN-R/R-55, CN-R/D-55	12		
Replace ◆ in Model No. with G for Galvanized finish or for *Powder Coated finish colors use the letter designations on Page 57.				

*See Pages 57 – 59 for optional lumber species, material color options, and the character designators to specify those options in the Model Numbers.

STEEL LIDS - Round and Square (Catalog Page 71)		16 Ga. Steel, *Powder Coated finish.		
Model No.	Description	Receptacles used with	Wt. (lbs.)	Price
24" Round Lids: 16 Ga. Steel, 24" I.D., 24-1/8" O.D.				
T/◆-2410	10" dia. hole	TRH-32, 55 gal. barrel inside TRH-55, CN-AMR-32, CN-R/R-32, CN-R/D-32, CN-R/SS2-36, CN-R/SS2-36D, CN-EXP52, CN-R/SP2-32, CN-TR-52, CN-R/SS3-36, RA's	10	\$145.00
T/◆-2410R	10" dia. hole, 12" bolt-on Rain Cover		12	\$176.00
T/◆-2410A	10" dia. hole, 6" dia. Ash Tray in bolt-on Rain Cover		13	\$214.00
27" Round Lids: 16 Ga. Steel, 27-1/8" I.D., 27-1/4" O.D.				
T/◆-2710	10" dia. hole	fits on top ring of TRH-55, CN-R/R-52, CN-R/D-52, CN-R/R-55, CN-R/D-55	13	\$164.00
T/◆-2710R	10" dia. hole, 12" bolt-on Rain Cover		15	\$195.00
T/◆-2710A	10" dia. hole, 6" dia. Ash Tray in bolt-on Rain Cover		16	\$233.00
24" Square Lids: 16 Ga. Steel, 23-5/8" I.D., 23-3/4" O.D.				
TQ/◆-2410	10" dia. hole,	CN-AMQ-32, TRQ-32, CN-Q-36, CN-Q/SS4-36D	10	\$165.00
TQ/◆-2410R	10" dia. hole, 12" bolt-on Rain Cover		12	\$196.00
TQ/◆-2410A	10" dia. hole, 6" dia. Ash Tray in bolt-on Rain Cover		13	\$234.00
Replace ◆ in Model No. with letter designations on Page 57 for *Powder Coated finish color selections.				

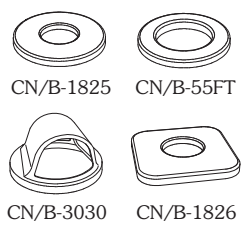
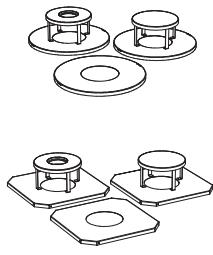

MOLDED PLASTIC LIDS - Round and Square (Catalog Page 71)				
Model No.	Size/Description	Wt. (lbs.)	Price	
Round Lids - fits TRH-32, 55 gal. barrel inside TRH-55, CN-AMR-32, CN-R/R-32, CN-R/D-32, CN-R/SS2-36, CN-R/SS2-36D, CN-EXP52, CN-R/SP2-32, CN-TR-52, CN-R/SS3-36, RA's, 55 gal. barrel				
CN/B-1825	24-3/8" I.D., 25" O.D., Black Plastic Lid, 10" dia. hole	4	\$99.00	
CN/B-55FT	24" I.D., 24-3/4" O.D., Black Plastic Lid, 15" dia. hole	4	\$99.00	
CN/B-3030	24-1/8" I.D., 24-1/2" O.D., Black Plastic Canopy Lid, 14-1/2" x 6-3/4" opening at each end	5	\$122.00	
Square Lid - fits CN-AMQ-32, TRQ-32, CN-Q-36, CN-Q/SS4-36D				
CN/B-1826	23-3/8" I.D., 24" O.D., Black Plastic Lid, 10" dia. hole	6	\$99.00	

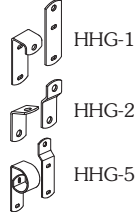

HASP and HINGE KITS (Catalog Page 72)				
Model No.	Description	Price		
HHG-1	Hinge and Hasp Kit of galvanized steel, mounts T-19 or T-24 Lids to 30 or 55 gal. barrels, zinc plated fasteners	\$15.00		
HHG-2	Hinge and Hasp Kit of galvanized steel, mounts T-22, T-24, or T-27 Lids to the top frame ring of TRH Series Receptacle Holders and RA Recycling Array Receptacles, galvanized fasteners			
HHG-5	Hinge and Hasp Kit of galvanized steel, Mounts T-19 or T-24 Lids to 30 or 55 gal. barrels, zinc plated fasteners, barrel edge spacer			

LID SECURITY KITS (Catalog Page 72)				
Model No.	Size/Description	Price		
CK-1	Chain Kit: 40" of Galvanized, 1/8" welded-link Steel Chain and (2) Galvanized, Equal Leg "S" Hooks, for use with RPP Can Hangers	\$11.00		
CK-5	Cable Kit: 36" of Plastic Coated 1/8" Steel Cable with (2) Aluminum Crimp Sleeves	\$6.00		
CK-6	Multiple Application Chain Kit: 24" of Galvanized, 1/8" welded-link Steel Chain, (1) Eyescrew, (2) Equal Leg "S" Hooks, (2) Unequal Leg "S" Hooks	\$12.00		
WSK-1	Web Strap Kit: 1" x 14" of Woven Nylon Strap with Snap Hook and Grommet Hole, (1) "D" Ring, (1) "S" Hook	\$11.00		
PL-1	Padlock: Precision Brass Tumbler and Case, keyed alike, 2-1/2" overall	\$12.00		

BAND IT® Premium Elastic Trash Can Loops (Catalog Page 72)				
Model No.	Description	Wt. (lbs.)	Price	
CN-BANDIT44455	(1) Case of 36 - fits 20 to 55 Gal. Plastic Liners, Galvanized Trash Cans, and Barrels - Minimum Order: 1 Case	3	\$122.00	

RECYCLING DECALS for LIDS (Catalog Page 72)				
Model No.	Message	Description	Price Each	
DE-1	"CANS ONLY" Recycling Decal	Size: 3" x 15" Recycling Green Lettering on adhesive backed, White Vinyl Plastic, with Recycling Symbol (except for "Trash Only")	\$12.00	
DE-2	"PAPER ONLY" Recycling Decal			
DE-3	"PLASTIC ONLY" Recycling Decal			
DE-4	"GLASS ONLY" Recycling Decal			
DE-5	"ALUMINUM ONLY" Recycling Decal			
DE-11	"TRASH ONLY" Decal			
DE-19	"RECYCLE ONLY" Recycling Decal			
Custom Decals	Custom message: Same size and colors as above. Min order: (15) of same design.	\$15.00		
Custom Design	Specify size, shape, and color; a minimum quantity may apply - Please Inquire			

*See Pages 57 - 59 for optional lumber species, material color options, and the character designators to specify those options in the Model Numbers.

RJ Thomas Mfg. Co., Inc.

P.O. Box 946 • Cherokee, Iowa 51012-0946 • ORDERS Toll Free: 800-762-5002 • FAX: 712-225-5796 • 712-225-5115

REGULAR DUTY GALVANIZED STEEL TRASH CANS (Catalog Page 73)							
Pregalvanized sheet steel can, 27 Ga. can and cover							
Model No.	Description	Capacity	O.D. (in.)	Height (in.)	Use with these Receptacle Holders	Wt. (lbs.)	Price
CNG-2310C	Can without lid	31 Gal.	20-1/2	27	CN-R/SS2-36, CN-R/SS2-36D, CN-R/SP2-32, CN-R/R-32, CN-R/D-32, CN-Q/D-32/2, CN-Q-36, CN-Q/SS4-36D, TRH-32, TRQ-32, TRH-55/SO, CN-AMR-32, CN-AMQ-32, CN-R/SS3-36, RPP Post, CH-4 Post, RA Arrays, CN-R/SP3-36D, CN-VDT-32, HCB-1	10	\$89.00
CNG-2310CL	Can and lid					12	\$110.00

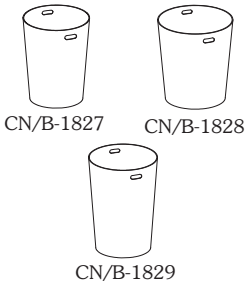

HEAVY DUTY RIGID PLASTIC LINERS (Catalog Page 73)							
Model No.	Capacity	O.D., Top (in.)	O.D., Bottom (in.)	Height (in.)	Use with these Receptacle Holders	Wt. (lbs.)	Price
CN/B-1827	36 Gal.	21	18	28	CN-R/SS2-36, CN-R/SS2-36D, CN-R/SP2-32, CN-R/R-32, CN-R/D-32, CN-Q/D-32/2, CN-Q-36, CN-Q/SS4-36D, TRH-32, TRQ-32, TRH-55/SO, CN-AMR-32, CN-AMQ-32, CN-EXP52, CN-R/SS3-36, CN-TR-52, RA Arrays, CN-R/SP3-36D, BPRT Series	10	\$115.00
CN/B-1828	52 Gal.	25	22	29	CN-R/R-52, CN-R/D-52	11	\$124.00
CN/B-1829	55 Gal.	23-5/8	20-7/8	35	CN-R/R-55, CN-R/D-55, TRH-55	14	\$135.00

RIGID PLASTIC LINER (Catalog Page 73) Lighter weight plastic, molded in handles, color may vary							
Model No.	Capacity	O.D. (in.)	Height (in.)	Use with these Receptacle Holders	Wt. (lbs.)	Price	
CN-4132C	30 Gal.	23	27	CN-R/SS2-36, CN-R/SS2-36D, CN-R/SP2-32, CN-R/R-32, CN-R/D-32, CN-Q/D-32/2, CN-Q-36, CN-Q/SS4-36D, TRH-32, TRQ-32, TRH-55/SO, CN-AMR-32, CN-AMQ-32, CN-R/SS3-36, RA Arrays, CN-R/SP3-36D, BPRT Series	5	NA	



FEDERAL-DUTY GALVANIZED STEEL TRASH CANS (Catalog Page 73)							
23 ga. steel can and cover galvanized to ASTM A123 or A653 to meet Federal Specifications NSN: 7240-00-160-0440 and -0441							
Model No.	Description	Capacity	O.D. (in.)	Height (in.)	Use with these Receptacle Holders	Wt. (lbs.)	Price
CNG-WHD24C	Can without lid	24 Gal.	19-1/2	23-1/2	TRH-20	15	\$227.00
CNG-WHD24CL	Can and lid					18	\$280.00
CNG-WHD32C	Can without lid	32 Gal.	21-1/4	26-1/4	CN-R/SS2-36, CN-R/SS2-36D, CN-R/SP2-32, CN-R/R-32, CN-R/D-32, CN-Q/D-32/2, CN-Q-36, CN-Q/SS4-36D, TRH-32, TRQ-32, TRH-55/SO, CN-AMR-32, CN-AMQ-32, CN-R/SS3-36, RPP Post, CH-4 Post, RA Arrays, CN-R/SP3-36D, CN-VDT-32, HCB-1	19	\$241.00
CNG-WHD32CL	Can and lid					22	\$294.00



STATIONARY MOUNTS for TRASH and ASH RECEPTACLES (Catalog Page 74)							
Model No.	Size/Description	Wt. (lbs.)	Price				
Elevated Pedestal Mounts for Trash Receptacles - 2-3/8" O.D. steel pipe Base Post with structural steel angle Cross Arms							
M2/◆	Embedded Pedestal Mount, (3) cross arms - fits TRH-32, TRQ-32, CN-R/R-32, CN-R/D-32, CN-Q/D-32/2, CN-R/SS2-36, CN-R/SS2-36D, CN-R/SP2-32, CN-R/SS3-36, CN-Q/SS4-36D	12	\$59.00				
M8/◆	Embedded Pedestal Mount, (4) cross arms - fits TRH-55, CN-AMR-32, CN-AMQ-32, CN-R/R-52, CN-R/D-52, CN-R/R-55, CN-R/D-55						
M3/◆	Surface Pedestal Mount with 1/4" x 8" square Base Plate, (3) cross arms - fits TRH-32, TRQ-32, CN-R/R-32, CN-R/D-32, CN-Q/D-32/2, CN-R/SS2-36, CN-R/SS2-36D, CN-R/SP2-32, CN-R/SS3-36, CN-Q/SS4-36D	12	\$59.00				
M7/◆	Surface Pedestal Mount with 1/4" x 8" square Base Plate, (4) cross arms - fits TRH-55, CN-AMR-32, CN-AMQ-32, CN-R/R-52, CN-R/D-52, CN-R/R-55, CN-R/D-55						
Ground Level Stationary Mount for Trash Receptacles							
M6/B	Seasonal Ground Anchors, set of 4 steel rods to install through holes in Cross Braces of Base Ring, Black Enamel finish only - fits all TRH-32, TRH-55, TRH-55/SO, TRQ-32, CN-AMR-32, CN-AMQ-32, CN-EXP52, CN-R/R-32, CN-R/D-32, CN-Q/D-32/2, CN-R/SS2-36, CN-R/SS2-36D, CN-R/SS3-36, CN-Q/SS4-36D, CN-R/SP2-32, CN-R/R-52, CN-R/D-52, CN-R/R-55, CN-R/D-55. Included with RA Series Arrays.	4	Black Enamel \$26.00				

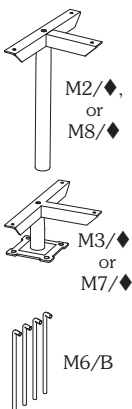

Replace ◆ in Model No. with G for Hot-Dip Galvanized finish or for *Powder Coated finish color use the letter designations on Page 57.

*See Pages 57 - 59 for optional lumber species, material color options, and the character designators to specify those options in the Model Numbers.

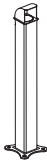

SMOKER'S STACK (Catalog Page 74)			
Steel Square Outer Mounting Post, 3-1/2" diameter Steel Inner Collection Tube with Weather Hood, Base Plate Installation with Concrete Anchor Bolts included			
Model No.	Size/Description	Wt. (lbs.)	Price
SS/P/◆-1	Smoker's Stack, 4" x 4" x 40" high, *Powder Coated finish, includes identification Decal	33	\$328.00
SS/P/◆-CT	Collection Tube only, *Powder Coated finish	15	\$179.00
Replace ◆ in Model No. with the letter designations on Page 57 for *Powder Coated finish color choices.			

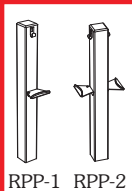

TRASH CAN HANGER - RECYCLED PLASTIC POST (Catalog Page 75) - 6" x 6" x 5 ft. Post of 100% Recycled Plastic			
Model No.	Description	Wt. (lbs.)	Price
RPP/◆-1	Post with Hot-Dip Galvanized Hardware to hang (1) Can, includes (1) CK-1 Chain kit	65	\$166.00
RPP/◆-2	Post with Hot-Dip Galvanized Hardware to hang (2) Cans, includes (2) CK-1 Chain kits	69	\$183.00
Replace ◆ in Model No. with the letter designations on Page 58 for *Recycled Plastic color choices.			
WP/G-H	Hot-Dip Galvanized Hardware for above Posts, (1) set hangs (1) can	4	\$50.00
CK-1	Chain Kit for (1) Can: 40" of Galvanized, 1/8" welded-link Steel Chain and (2) Galvanized, Equal Leg "S" Hooks		\$11.00

DISCONTINUED



TRASH CAN HANGER - STEEL POST (Catalog Page 75)			
1-7/8" O.D. Steel Pipe Post, adjustable Hooks and Bottom Support			
Model No.	Description	Wt. (lbs.)	Price
CH/◆-4	Can Hanger with (4) Can Capacity	15	\$108.00
Replace ◆ in Model No. with G for Hot-Dip Galvanized finish or the letter designations on Page 57 for optional *Powder Coated finish color choices.			
CK-1	Optional Chain Kit for (1) Can: 40" of Galvanized, 1/8" welded-link Steel Chain and (2) Galvanized, Equal Leg "S" Hooks		\$11.00

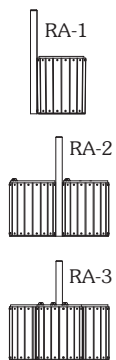

RECYCLING ARRAYS - RA Series (Catalog Page 76)			
Recycling Arrays use TRH-32 Trash Receptacle Holders with 1" x 4" Recycled Plastic Slats for the Modules and a 4" x 4" Recycled Plastic Center Post when a Center Post is included. Hot-Dip Galvanized Frames. Model DE-10 Wrap-around Recycling Decal included with Center Post. Ground Anchors provided to secure the Modules. NO lids or liners are included with the Arrays.			
Model No.	Description	Wt. (lbs.)	Price
RA1/G-◆	1 Module, Center Post	106	\$576.00
RA2/G-◆	2 Module, Center Post	189	\$1,057.00
RAX2/G-◆	2 Module, NO Center Post	166	\$989.00
RA3/G-◆	3 Module, Center Post	272	\$1,518.00
RAX3/G-◆	3 Module, NO Center Post	249	\$1,445.00
DE-10	Wrap-around Post Recycling Decal, 12" x 17", with "RECYCLE" and Recycling Symbol in Recycling Green on adhesive backed, White Vinyl Plastic		\$16.00
Replace ◆ in Model No. with the letter designations on Page 58 for *Recycled Plastic color choices for Slats and Center Post.			
T-24 Series Steel Recycling Lids are listed on Page 37 of this price list. Hinge/Hasp Kits to mount these lids to the top frame ring of the TRH-32 Modules are on Page 38. Cans and Liners are on Pages 39. Other Recycling Lids, Trash Can Lids, and Dome Lids can be used on the Arrays -see Pages 36-38.			

CUSTOM SIGNAGE -for Trash Receptacles with Recycled Plastic Slats (Catalog Page 25)		
ENGRAVED and RESIN FILLED LETTERS	Custom engraved lettering on Recycled Plastic up to a maximum height of 3" per letter (for larger letters, please inquire). May be filled with colored resin. A drawing of the layout will be provided for approval.	Price
	Set-up Charge per unique line of text on a slat -if text changes another charge applies	\$35.00
	Cost per 3" Routed Letter, in addition to the initial Set-up Charge (for larger letters, please inquire)	\$6.00
	Cost per 3" Routed Letter with Colored Resin Fill, in addition to the initial Set-up Charge (for larger letters, please inquire)	\$12.00

*See Pages 57 - 59 for optional lumber species, material color options, and the character designators to specify those options in the Model Numbers.

PILOT ROCK PET WASTE COLLECTION STATION (Catalog Page 76)			
Model No.	Size/Description	Wt. (lbs.)	Price
PWS-D006	Complete Pet Waste Station – Bags On A Roll: Pet Waste Roll Bag Dispenser (Model PWS-D003); 11 gal. capacity, Forest Green powder coated aluminum Waste Can with self closing lid (Model PWS-D004); 10" x 12" Sign (Model PWS-D008) and sign bracket; 84" long, 2-section, Galvanized solid steel Post; 400 waste collection bags; 50 waste can liner bags; all assembly hardware and instructions	42	\$441.00
PWS-D003	Pet Waste Roll Bag Dispenser only: 10" wide x 18" long x 3-1/2" deep, Forest Green powder coated aluminum fabrication, lockable; (3) dispensing openings to hold (3) 200 count boxes of waste collection bags; stores (2) extra boxes – 1000 total bag capacity	5	\$124.00
PWS-D001	Pet Waste Bags on a Roll Case: 8" wide x 13" long 100% biodegradable bags, 200 bags per box – 10 boxes per case	14	\$124.00
PWS-D002	Waste Can Liner Bags Case: 27.5" wide x 29" long 100% biodegradable bags, 50 bags per box – 4 boxes per case	19	\$124.00
PWS-D004	Waste Can only: 11 gal. capacity, Forest Green powder coated aluminum with self closing lid	10	\$220.00
PWS-D008	Sign (replacement): 10" wide x 12" tall, White/Forest Green powder coated aluminum	2	\$33.00
OPTIONAL PET WASTE STATION			
PWS-D022	Complete Pet Waste Station – Bags On A Card: Bags On A Card Dispenser (Model PWS-D019); 11 gal. capacity, Forest Green powder coated aluminum Waste Can with self closing lid; 10" x 12" Sign (Model PWS-D008) and sign bracket; 84" long, 2-section, Galvanized solid steel Post; 400 waste collection bags; 50 waste can liner bags; all assembly hardware and instructions	42	\$441.00
PWS-D019	Bags On A Card Dispenser only: Forest Green powder coated aluminum, lockable, 600 bag storage capacity	5	\$143.00
PWS-D021	Bags On A Card Refill Case: 9-1/2" wide x 15" long bags, 3200 Bags per case	60	\$234.00
PWS-D999	MittN Bags On A Card Refill Case: 8" wide x 12-1/2" long with 5" Mitten Pouch, 2000 Bags per case. Will fit all bags-on-card header dispensers.	12	\$180.00



DOGIPOT – PET WASTE COLLECTION SYSTEM (Catalog Page 76)			
Model No.	Size/Description	Wt. (lbs.)	Price
PWS-DOGI1010	Complete DogiPot Pet Waste Station: Commercial quality polyethylene Junior Bag Dispenser – 400 Bag capacity (Model PWS-DOGI1007-2) and Trash Receptacle with lid (10 gal. capacity) – Forest Green color; fiberglass telescoping Post (4' to 8'), 18" x 12" aluminum Sign, (2) Rolls of 200 ea. Oxo-Biodegradable Litter Pick Up Bags, (1) Box of 50 Receptacle Liner Bags, fasteners and instructions	28	\$454.00
PWS-DOGI1007-2	DogiPot Junior Bag Dispenser only: – Forest Green color, includes (2) Rolls of 200 ea. Litter Pick Up Bags	5	\$146.00
PWS-DOGI1402-10	Litter Pick Up Bags: 8" wide x 13" long, Oxo-Biodegradable, opaque green, 200 bags per box – Minimum Order: (1) case of (10) boxes (2000 Bags)	12	\$152.00
PWS-DOGI1404-2	Receptacle Liner Bags: 10 gal., opaque black, draw tape close, (2) Boxes of 50 Bags each	10	\$75.00



DOG PARK PRODUCTS

PLAYGROUNDS FOR DOGS (Catalog Page 78)			
Model No.	Size/Description	Wt. (lbs.)	Price
DPE-DOGI7522	Dogi-Jump Hoops: Dog shaped, 3-level Hoops, 22.5" I.D.; welded steel fabrication, Green thermo-plastic coating; (2) in-ground mounting posts with powder coat finish; 80" wide x 42" tall (installed)	80	\$1,076.00
DPE-DOGI7731	Fire Hydrant: Decorative Fire Hydrant molded with unsaturated poly resin; coated with Red poly urethane paint to seal out urine; (4) in-ground mounting j-rods powder coated Red; 33" high x 15" wide (installed)	29	\$537.00
DPE-DOGI7523	3-Level Steel Jump Hurdles: (3) Hurdles, 11 ga. x 3" O.D. steel tube; textured powder coat finish; (2) Green, (1) Beige; (6) in-ground mounting posts with powder coat finish; dimensions (installed): #1: 41" wide x 6" high; #2: 48" wide x 12" high; #3: 55" wide x 18" high;	90	\$1,481.00
DPE-DOGI7511	Rectangular Bone Table: 11 ga. steel with perforated bone-shaped artwork, Green Ruffcoat™ protective slip resistant coating; (4) legs of 13 ga. 4 x 4 in. square steel tube with Beige powder coat finish; (4) in-ground mounting posts with powder coat finish; 60" long x 24" wide x 12" high (installed); holds up to 500 lbs. maximum weight	135	\$1,302.00
DPE-DOGI7531	Dogi-Tunnel: Aluminum tunnel, 36" I.D. x 46" long, Green powder coat finish; (4) legs of 2" square steel tube with Beige powder coat finish; (4) in-ground mounting posts with powder coat finish; 59" tall (at tail) x 44.5" wide x 46" long, 9" high at bottom of tunnel (installed); includes (1) tail and (2) ears	210	\$3,500.00
DPE-DOGI7521	Arched Stepping Bones: (5) Steps 12" x 16" wide, 11 ga. steel with perforated bone-shape artwork, Green Ruffcoat™ protective slip resistant coating; Steps are 12", 18", and 24" high; 13 ga. 2.375 square steel tube framework with Beige powder coat finish; (3) in-ground mounting posts with powder coat finish; 84" wide x 16" deep x 24" tall (installed); Holds up to 200 lbs. maximum weight	155	\$2,152.00

DOG PARK PRODUCTS ...FOR PEOPLE (Catalog Page 79)			
Furnish your dog park with durable and comfortable site amenities for the people enjoying the park along with their pets. Many of our products can include custom artwork or signage with certain limitations based on materials and size. Contact us for more details.			
Picnic Tables: Rectangular, square, and round perforated steel tables can include your preferred dog art (within the limits of material, perforating process, and size).			
Park Benches: Park Benches can include custom art, plaques, or signage in laser cut steel plate, perforated steel, recycled plastic, and our Sign Benches.			
Trash Receptacles: Keep your dog park clean with our selection of Trash Receptacles. We offer a variety of sizes, materials, colors, and lids to go with them that are suitable for dog artwork. Depending on the material, perforated steel, laser cut steel, routed recycled plastic, plaques, or decals are all an option.			

*See Pages 57 – 59 for optional lumber species, material color options, and the character designators to specify those options in the Model Numbers.

RJ Thomas Mfg. Co., Inc.

P.O. Box 946 • Cherokee, Iowa 51012-0946 • **ORDERS Toll Free: 800-762-5002** • FAX: 712-225-5796 • 712-225-5115

SITE AMENITIES

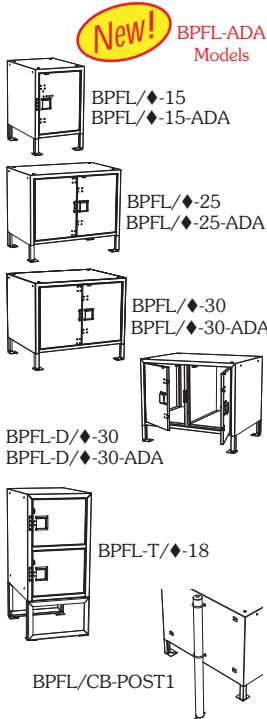

CERTIFIED BEAR RESISTANT FOOD STORAGE LOCKERS (Catalog Pages 80 & 81)									
All welded construction, heavy 12 ga. steel plate top, side, and door panels, bolted-in 12 ga. pre galvanized steel plate bottom panel, corner brace/leg posts of 12 ga. formed channel nested inside the formed channel side panel wraps, full-length heavy ga. stainless steel piano door hinges, (4) leveling feet, textured Powder Coated finish, includes (4) 1/2" x 5" heavy duty concrete screw anchors (Model ANC5-4). Model BPFL-T/◆-18 Trail Side Locker includes (2) bolt-on Support Bases, each with (2) leveling feet to anchor the unit. The companion Models with the "-ADA" suffixes are the same lockers engineered for a raised height to align with accessibility guidelines. The design elevates the locker height to ensure convenient and inclusive access for all users without compromising functionality or style.									
Model No.	IGBC Certification Number	Inside Capacity (cu. ft.)	Number of Doors	Locker Box Outside Dimensions H x W x D (in.)	Overall Height (in.) (levelers not engaged)	Anchor Kit included	Wt. (lbs.)	Price	
BPFL/◆-15	5104	15	1	33 x 26 x 34-1/2	40-3/8	ANC5-4	250	\$1,212.00	
BPFL/◆-15-ADA							260		
BPFL/◆-25	5123	25	2	33 x 47-3/4 x 30-1/2	40-3/8		347	\$1,365.00	
BPFL/◆-25-ADA							357		
BPFL/◆-30	5105	30	2	33 x 47-3/4 x 37-1/2	40-3/8		381	\$1,527.00	
BPFL/◆-30-ADA							391		
BPFL-D/◆-30	5258	15 -each compartment	2	33 x 49-3/8 x 37-1/2	40-3/8		438	\$1,656.00	
BPFL-D/◆-30-ADA							448		
BPFL-T/◆-18	5263	9 -each compartment	2	41-3/4 x 25-3/4 x 35-3/4	58		280	\$1,312.00	
Model No.	Size/Description						Wt. (lbs.)	Price	
DE-36/2	NA	Optional "Food Storage" Decal, 5" x 6", Black on White Vinyl Plastic					N/A	\$35.00	
BPFL/CB-POST1	NA	Optional Embedded Post Mount, 3-1/2" O.D. x 61-1/4" long steel Post, Black Powder Coated finish, all installation Hardware included. Not available on Model BPFL-T/◆-18 Trail Side Locker.					26	\$208.00	
Replace ◆ in Model No. with CWT for Brown, CNT for Green, CBT for Black, CUT for Blue, or CTT for Speckled Tan textured Powder Coated finish.									

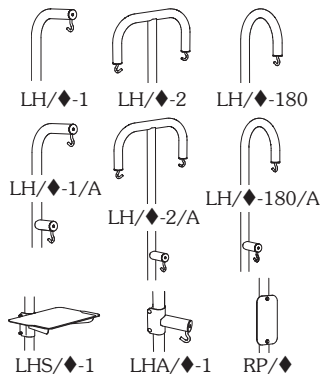

LANTERN HOLDERS (Catalog Page 82)			
2-3/8" O.D. Steel Post. Standard: Hot-Dip Galvanized finish. Optional: *Powder Coated finish.			
Model No.	Size/Description	Wt. (lbs.)	Price
LH/◆-1	Single Lantern Holder	35	\$222.00
LH/◆-1/A	Single Lantern Holder, with welded-on Wheelchair Accessible Arm	37	\$276.00
LH/◆-2	Double Lantern Holder	47	\$294.00
LH/◆-2/A	Double Lantern Holder, with welded-on Wheelchair Accessible Arm	49	\$348.00
LH/◆-180	Single Lantern Holder	41	\$322.00
LH/◆-180/A	Single Lantern Holder, with welded-on Wheelchair Accessible Arm	43	\$376.00
LHS/◆-1	Shelf, bolt-on	16	\$172.00
LHA/◆-1	Wheelchair Accessible Lantern Hook Arm, bolt-on	4	\$88.00
RP/◆	Rules Plate, bolt-on	4	\$52.00
Replace ◆ in Model No. with G for Hot-Dip Galvanized finish or for *Powder Coated finish colors use the letter designations on Page 57.			

TRAFFIC BARRIER (Catalog Page 83)			
Model No.	Size/Description	Wt. (lbs.)	Price
TB/◆-1	Tilt-down Traffic Barrier: 3-1/2" O.D. x 1/8" wall Steel Pipe Post, 3/8" x 10" sq. Base Plate, Powder Coated finish, stainless steel Bolt and 3/4" dia. Pin. Includes (4) 1/2" x 3" concrete Anchor Screws, Brass Padlock, Reflective Decals.	32	\$348.00
Replace ◆ in Model No. with CY for standard Yellow Powder Coated finish. For other colors use the letter designations on Page 57.			

BOLLARD BARRICADE (Catalog Page 83)			
Model No.	Size/Description	Wt. (lbs.)	Price
TB/◆-2	Embedded Post Bollard Barricade: 4-1/2" O.D. x 10 ga. wall Steel Pipe Post, 41-3/8" tall, Powder Coated finish, includes Reflective Decals	34	\$179.00
TB/P/◆-2	Base Plate Post Bollard Barricade: 4-1/2" O.D. x 10 ga. wall Steel Pipe Post, 41-3/8" tall, Powder Coated finish, 3/8" x 10" sq. Base Plate; includes (4) 1/2" x 5" concrete Anchor Screws, Reflective Decals.	34	\$179.00
Replace ◆ in Model No. with CY for standard Yellow Powder Coated finish. For other colors use the letter designations on Page 57.			

*See Pages 57 – 59 for optional lumber species, material color options, and the character designators to specify those options in the Model Numbers.

RJ Thomas Mfg. Co., Inc.

P.O. Box 946 • Cherokee, Iowa 51012-0946 • ORDERS Toll Free: 800-762-5002 • FAX: 712-225-5796 • 712-225-5115

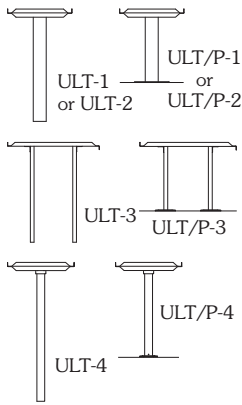

UTILITY TABLES - ULT Series (Catalog Page 84)			
All steel construction, 3/16" steel plate top; Black Textured Powder Coat finish (denoted by /CBT in model no.)			
Model No.	Size/Description	Wt. (lbs.)	Price
ULT/CBT-1	18" deep x 30" wide top, 32" high, single 4" x 6" steel tube post; concrete embedment	123	\$453.00
ULT/P/CBT-1	18" deep x 30" wide top, 32" high, single 4" x 6" steel tube post; base plate surface mount	123	
ULT/CBT-2	18" deep x 48" wide top, 32" high, single 4" x 6" steel tube post for concrete embedment	134	\$506.00
ULT/P/CBT-2	18" deep x 48" wide top, 32" high, single 4" x 6" steel tube post; base plate, surface mount	134	
ULT/CBT-3	30" deep x 48" wide top, 32" high, double 6" x 8.2" steel channel posts for concrete embedment	200	\$733.00
ULT/P/CBT-3	30" deep x 48" wide top, 32" high, double 6" x 8.2" steel channel posts with base plates for surface mount	200	
ULT/CBT-4	18" deep x 30" wide swivel top, 40" high, single 3-1/2" O.D. steel tube post for concrete embedment	80	\$374.00
ULT/P/CBT-4	18" deep x 30" wide swivel top, 40" high, single 3-1/2" O.D. steel tube post with base plate for surface mount	80	

FULL SIZE UTILITY TABLE - APTX Series
(Catalog Page 85)

30" (nom.) table top height, (2) 3" x 6" Rectangular Steel Posts
APTX: Long Posts for embedded installation.
APTX/P: Base Plate Posts for surface mount

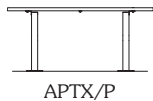
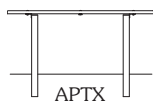

❄️ Snow Load Table - see Page 29

Powder Coated Frames, Black standard *(/CB)		Hot-Dip Galvanized Frames (/G)			
APTX Series 6 ft. with Long Posts					
Model No.	Model No.	Material	Wt. (lbs.)	Price	
APTX/CB-6UP	APTX/G-6UP	*Untreated #1 Southern Yellow Pine	132	\$368.00	
APTX/CB-6TP	APTX/G-6TP	*Treated #1 Southern Yellow Pine	132	\$372.00	
APTX/CB-6AL	APTX/G-6AL	Clear Anodized Aluminum	99	\$724.00	
APTX/CB-6AR	APTX/G-6AR	*Red Powder Coated Aluminum	99	\$724.00	
APTX/CB-6PC	APTX/G-6PC	*Cedar colored Recycled Plastic	176	\$670.00	
APTX/CB-6VW ❄️	APTX/G-6VW ❄️	*Brown V-type Expanded Steel	149	\$763.00	
APTX/CB-6DW	APTX/G-6DW	*Brown D-type Expanded Steel	115	\$634.00	
APTX/CB-6HW ❄️	APTX/G-6HW ❄️	*Brown H-type Perforated Steel	155	\$769.00	
APTX/CB-6RW	APTX/G-6RW	*Brown R-type Perforated Steel	121	\$710.00	
APTX/CB-6SC/TW	APTX/G-6SC/TW	*Brown Formed Steel Channel	144	\$710.00	
APTX/P Series 6 ft. with Base Plate Posts					
Model No.	Model No.	Material	Wt. (lbs.)	Price	
APTX/P/CB-6UP	APTX/P/G-6UP	*Untreated #1 Southern Yellow Pine	132	\$368.00	
APTX/P/CB-6TP	APTX/P/G-6TP	*Treated #1 Southern Yellow Pine	132	\$372.00	
APTX/P/CB-6AL	APTX/P/G-6AL	Clear Anodized Aluminum	99	\$724.00	
APTX/P/CB-6AR	APTX/P/G-6AR	*Red Powder Coated Aluminum	99	\$724.00	
APTX/P/CB-6PC	APTX/P/G-6PC	*Cedar colored Recycled Plastic	176	\$670.00	
APTX/P/CB-6VW ❄️	APTX/P/G-6VW ❄️	*Brown V-type Expanded Steel	149	\$763.00	
APTX/P/CB-6DW	APTX/P/G-6DW	*Brown D-type Expanded Steel	115	\$634.00	
APTX/P/CB-6HW ❄️	APTX/P/G-6HW ❄️	*Brown H-type Perforated Steel	155	\$769.00	
APTX/P/CB-6RW	APTX/P/G-6RW	*Brown R-type Perforated Steel	121	\$710.00	
APTX/P/CB-6SC/TW	APTX/P/G-6SC/TW	*Brown Formed Steel Channel	144	\$710.00	
APTX Series 8 ft. with Long Posts					
Model No.	Model No.	Material	Wt. (lbs.)	Price	
APTX/CB-8UP	APTX/G-8UP	*Untreated #1 Southern Yellow Pine	155	\$400.00	
APTX/CB-8TP	APTX/G-8TP	*Treated #1 Southern Yellow Pine	155	\$408.00	
APTX/CB-8AL	APTX/G-8AL	Clear Anodized Aluminum	111	\$879.00	
APTX/CB-8AR	APTX/G-8AR	*Red Powder Coated Aluminum	111	\$879.00	
APTX/CB-8PC	APTX/G-8PC	*Cedar colored Recycled Plastic	213	\$802.00	
APTX/CB-8VW ❄️	APTX/G-8VW ❄️	*Brown V-type Expanded Steel	175	\$932.00	
APTX/CB-8DW	APTX/G-8DW	*Brown D-type Expanded Steel	131	\$702.00	
APTX/CB-8HW ❄️	APTX/G-8HW ❄️	*Brown H-type Perforated Steel	181	\$950.00	
APTX/CB-8RW	APTX/G-8RW	*Brown R-type Perforated Steel	142	\$763.00	
APTX/CB-8SC/TW	APTX/G-8SC/TW	*Brown Formed Steel Channel	162	\$760.00	
APTX/P Series 8 ft. with Base Plate Posts					
Model No.	Model No.	Material	Wt. (lbs.)	Price	
APTX/P/CB-8UP	APTX/P/G-8UP	*Untreated #1 Southern Yellow Pine	155	\$400.00	
APTX/P/CB-8TP	APTX/P/G-8TP	*Treated #1 Southern Yellow Pine	155	\$408.00	
APTX/P/CB-8AL	APTX/P/G-8AL	Clear Anodized Aluminum	111	\$879.00	
APTX/P/CB-8AR	APTX/P/G-8AR	*Red Powder Coated Aluminum	111	\$879.00	
APTX/P/CB-8PC	APTX/P/G-8PC	*Cedar colored Recycled Plastic	213	\$802.00	
APTX/P/CB-8VW ❄️	APTX/P/G-8VW ❄️	*Brown V-type Expanded Steel	175	\$932.00	
APTX/P/CB-8DW	APTX/P/G-8DW	*Brown D-type Expanded Steel	131	\$702.00	
APTX/P/CB-8HW ❄️	APTX/P/G-8HW ❄️	*Brown H-type Perforated Steel	181	\$950.00	
APTX/P/CB-8RW	APTX/P/G-8RW	*Brown R-type Perforated Steel	142	\$763.00	
APTX/P/CB-8SC/TW	APTX/P/G-8SC/TW	*Brown Formed Steel Channel	162	\$760.00	

FULL SIZE UTILITY TABLE - APTX Series ... continued on Page 44

*See Pages 57 - 59 for optional lumber species, material color options, and the character designators to specify those options in the Model Numbers.

RJ Thomas Mfg. Co., Inc.

P.O. Box 946 • Cherokee, Iowa 51012-0946 • ORDERS Toll Free: 800-762-5002 • FAX: 712-225-5796 • 712-225-5115

FULL SIZE UTILITY TABLE - APTX Series ...continued

APTX Series with Long Post - FRAMES ONLY					APTX/P Series with Base Plate - FRAMES ONLY				
Frame only Kits include frame units, all fasteners and related hardware.					Frame only Kits include frame units, all fasteners and related hardware.				
Model No.	Length (ft.)	Use with	Wt. (lbs.)	Price	Model No.	Length (ft.)	Use with	Wt. (lbs.)	Price
APTX-6FR	6	Lumber, Aluminum, Expanded Steel, Perforated Steel, Formed Steel Channel	63	\$260.00	APTX/P-6FR	6	Lumber, Aluminum, Expanded Steel, Perforated Steel, Formed Steel Channel	63	\$260.00
APTX-8FR	8		63	\$260.00	APTX/P-8FR	8		63	\$260.00
APTX-6FRP	6	Recycled Plastic	79	\$313.00	APTX/P-6FRP	6	Recycled Plastic	79	\$313.00
APTX-8FRP	8		84	\$322.00	APTX/P-8FRP	8		84	\$322.00

UTILITY TABLE - XTX Series (Catalog Page 85)	Powder Coated Frames, Black standard */(CB) Model No.	Hot-Dip Galvanized Frames (/G) Model No.	Length (ft.)	Material	Wt. (lbs.)	Price
	30" (nom.) table top height, 2-3/8" O.D. steel pipe frames (2.375" O.D., 11 ga. wall 2" I.D. nom. pipe specifications) with formed, flattened feet for portable or surface mount installation. 2" x 2" x 3/16" structural steel top angles, 1-5/16" O.D. steel pipe diagonal braces.	XTX/CB-6UP				
XTX/CB-8UP		XTX/G-8UP	8	148	\$390.00	
XTX/CB-10UP		XTX/G-10UP	10	195	\$551.00	
XTX/CB-6TP		XTX/G-6TP	6	*Treated #1 Southern Yellow Pine	123	\$362.00
XTX/CB-8TP		XTX/G-8TP	8		148	\$398.00
XTX/CB-10TP		XTX/G-10TP	10		195	\$561.00
XTX/CB-6AL		XTX/G-6AL	6	Clear Anodized Aluminum	90	\$714.00
XTX/CB-8AL		XTX/G-8AL	8		104	\$869.00
XTX/CB-10AL		XTX/G-10AL	10		141	\$1,148.00
XTX/CB-6AR		XTX/G-6AR	6	*Red Powder Coated Aluminum	90	\$714.00
XTX/CB-8AR		XTX/G-8AR	8		104	\$869.00
XTX/CB-10AR		XTX/G-10AR	10		141	\$1,148.00
XTX/CB-6PC		XTX/G-6PC	6	*Cedar colored Recycled Plastic	167	\$661.00
XTX/CB-8PC		XTX/G-8PC	8		206	\$785.00
XTX/CB-6DW		XTX/G-6DW	6	*Brown Thermo-plastic Coated D-type Expanded Steel	106	\$625.00
XTX/CB-8DW		XTX/G-8DW	8		124	\$691.00
XTX/CB-10DW		XTX/G-10DW	10		167	\$915.00
XTX/CB-6RW		XTX/G-6RW	6	*Brown Thermo-plastic Coated R-type Perforated Steel	112	\$701.00
XTX/CB-8RW		XTX/G-8RW	8		135	\$752.00
XTX/CB-10RW		XTX/G-10RW	10		177	\$991.00
XTX/CB-6SC/TW	XTX/G-6SC/TW	6	*Brown Thermo-plastic Coated Formed Steel Channel	135	\$701.00	
XTX/CB-8SC/TW	XTX/G-8SC/TW	8		155	\$752.00	

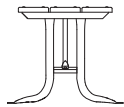

UTILITY TABLE - XTX Series - FRAMES ONLY					Frame only Kits include frame units, all fasteners and related hardware.				
Model No.	Length (ft.)	Use with	Wt. (lbs.)	Price	Model No.	Length (ft.)	Use with	Wt. (lbs.)	Price
XTX-6FR	6	Lumber, Aluminum, Expanded Steel, Perforated Steel, Formed Steel Channel	54	\$250.00	XTX-6FRP	6	Recycled Plastic	70	\$303.00
XTX-8FR	8		56	\$250.00	XTX-8FRP	8		77	\$311.00
XTX-10FR	10		81	\$375.00					

SQUARE FRAME PICNIC and UTILITY TABLES - T700 Series (Catalog Page 85)
 Square end frame design with 2" x 2" x 11 ga. square steel tube end frames, surface mount only. 1" x 2" x 14 ga. rectangular steel tube top and seat frames with formed steel reinforcements, factory inlaid 2" x 4" nom. recycled plastic top and seat slats. Most models provide ADA compliant access. **Powder Coated Frames**, Black standard */(CB)



Model No.	Length (ft.)	Bench Seats	ADA Compliant Access	Top and Seat Inlay Material	Wt. (lbs.)	Price
T700 Series Rectangular UTILITY TABLES						
T700/CB-6PC	6, Rectangular	None	Yes - All Sides	*Cedar Colored Recycled Plastic	163	\$687.00
T700/CB-8PC	8, Rectangular	None	Yes - All Sides		211	\$814.00
TQ700 Series Square UTILITY TABLES						
TQ700/CB-4PC	4, Square	None	Yes - All Sides	*Cedar Colored Recycled Plastic	145	\$639.00

*See Pages 57 - 59 for optional lumber species, material color options, and the character designators to specify those options in the Model Numbers.

CONDIMENT SERVING TABLE - CST Series (Catalog Page 86)	Powder Coated Frames, Black standard *(/CB) Model No.	Hot-Dip Galvanized Frames (/G) Model No.	Length (ft.)	Material	Wt. (lbs.)	Price
	CST/CB-4HW12	CST/G-4HW12				
46" (nom.) table top height, 2-3/8" O.D. steel pipe frame post, 3/16" thick steel top angle. CST/P: stationary surface mount with base plate CST: embedded installation	CST/CB-6HW12	CST/G-6HW12	4	(1) 2" x 12" *Brown Thermo-plastic Coated Perforated Steel Plank	58	\$317.00
	CST/CB-8HW12	CST/G-8HW12	6		67	\$406.00
	CST/CB-10HW12	CST/G-10HW12	8		77	\$459.00
	CST/P/CB-4HW12	CST/P/G-4HW12	4		107	\$608.00
	CST/P/CB-6HW12	CST/P/G-6HW12	6		58	\$317.00
	CST/P/CB-8HW12	CST/P/G-8HW12	8		67	\$406.00
	CST/P/CB-10HW12	CST/P/G-10HW12	10		77	\$459.00
					107	\$608.00

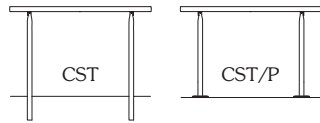

CST Series with Long Post - FRAMES ONLY			Prices are for both Hot-Dip Galvanized and Powder Coat finished models.		CST/P Series with Base Plate - FRAMES ONLY			Prices are for both Hot-Dip Galvanized and Powder Coat finished models.	
Model No.	Length (ft.)	Use with	Wt. (lbs.)	Price	Model No.	Length (ft.)	Use with	Wt. (lbs.)	Price
CST-4FR	4	Perforated Steel	32	\$134.00	CST/P-4FR	4	Perforated Steel	32	\$134.00
CST-6FR	6				CST/P-6FR	6			
CST-8FR	8				CST/P-8FR	8			
CST-10FR	10				CST/P-10FR	10			

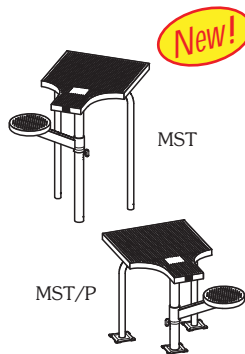

MARKSMAN SHOOTING TABLE (Catalog Page 86)			
Model No.	Description	Wt. (lbs.)	Price
MST/◆-1RN	*Green Thermo-plastic Coated Top and Seat, long post for concrete embedment	129	\$1,182.00
MST/P/◆-1RN	*Green Thermo-plastic Coated Top and Seat Top and Seat, base plate post for surface mount	129	\$1,182.00
Replace ◆ in Model No. with G for Hot-Dip Galvanized finish or for *Powder Coated finish colors use the letter designations on Page 57. *For other color choices for Thermo-plastic coated Perforated Steel Top and Seat, replace the RN in the above Model Nos. with the appropriate letter designation on Page 59.			
ANCI-4	Optional Set of (4) 1/2" x 3" heavy duty Concrete Screw Anchors, (3) Sets required.	2	\$12.00

PLANTERS (Catalog Page 87)			
Model No.	Size/Description	Wt. (lbs.)	Price
P-10 PLANTER 26-1/2" O.D. x 25" high			
P-10/◆-TP	Treated Pine 2" x 4" Slats, Hot-Dip Galvanized or Powder Coated Frame Rings, with rigid plastic Liner	63	\$298.00
P-10/◆-PC	*Cedar colored Recycled Plastic 2" x 4" Slats, Hot-Dip Galvanized or Powder Coated Frame Rings, with rigid plastic Liner	99	\$497.00
Replace ◆ in Model No. with G for Hot-Dip Galvanized finish or for *Powder Coated finish colors use the letter designations on Page 57. *For other color choices for Recycled Plastic 2" x 4" Slats replace the PC in the above Model No. with the appropriate letter designation on Page 58.			
P-22 PLANTER 29" O.D. x 23" high			
P-22/CU	All welded Steel Strap construction, *Blue Powder Coated finish, with rigid plastic Liner	64	\$566.00
P-23 PLANTER 29" O.D. x 25-1/2" high			
P-23/TW	Vertical Wave all welded Steel Strap construction, *Brown Thermo-plastic Coated finish, rigid plastic Liner	62	\$566.00
CN/B-3001F	Heavy duty, rigid plastic Planter Liner for all Planters, 20" tall x 20" nom. dia., Black	8	\$100.00

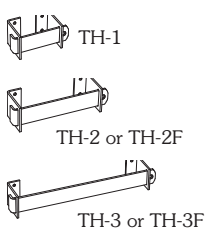

TOILET TISSUE DISPENSERS (Catalog Page 87)			Zinc Plated Finish	
Model No.	Size/Description	Wt. (lbs.)	Price	
TH-1	1 Roll Dispenser, 3/16" x 2" crossbar -rolls don't turn easily	2	\$41.00	
TH-2	2 Roll Dispenser, 3/16" x 2" crossbar -rolls don't turn easily	3	\$42.00	
TH-3	3 Roll Dispenser, 1/4" x 2" crossbar -rolls don't turn easily, also holds 1 roll of Paper Towels	4	\$45.00	
TH-2F	2 Roll Dispenser, 1/4" x 1-1/2" crossbar -rolls turn freely	3	\$46.00	
TH-3F	3 Roll Dispenser, 1/4" x 1-1/2" crossbar -rolls turn freely, also holds 1 roll of Paper Towels	4	\$48.00	
PL-1	Padlock: Precision Brass Tumbler and Case, keyed alike, 2-1/2" overall		\$12.00	

*See Pages 57 - 59 for optional lumber species, material color options, and the character designators to specify those options in the Model Numbers.

RJ Thomas Mfg. Co., Inc.

P.O. Box 946 • Cherokee, Iowa 51012-0946 • ORDERS Toll Free: 800-762-5002 • FAX: 712-225-5796 • 712-225-5115

New!

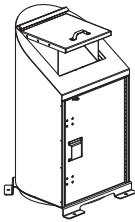

FRDB/CU-1

U.S. FLAG RETIREMENT DROP BOX				
All welded heavy steel construction, 12 and 14 gauge formed steel with 7 gauge reinforcing and base, 16" square 12 gauge tight fitting, hinged Hatch, stainless steel Hatch and Door hinges; front access Door is self-latching with covered Latch; interior Rain Gutter to drain away infiltrating moisture; Powder Coated finish; includes choice of Custom Decal Wrap, 36 gal. heavy duty rigid Plastic Liners, concrete Anchor Kit				
Model No.	Custom Decal Wrap choices – please specify	Anchor Kit included	Wt. (lbs.)	Price
FRDB/CU-1	Model DE-52: VFW custom decal wrap, Model DE-53: American Legion custom decal wrap, or Model DE-54: "other organization" custom decal wrap	Model ANC5-4 (4) 1/2" x 5" Concrete Anchors	170	\$1,750.00
Replace /CU in Model No. for standard Blue color with CN for Green, CW for Brown, CB for Black, CT for Tan, CA for Gray, CR for Red, CY for Yellow, or CE for Burgandy Powder Coated finish.				
Model No.	Description			Price
PL-1	Padlock: Precision Brass Tumbler and Case, keyed alike, 2-1/2" overall			\$12.00

WAYFINDING SIGNS

WAYFINDING and INFORMATIONAL SIGNS (Catalog Pages 88 & 89)
 Sign material is .120" thick with laminated white aluminum on both surfaces and a solid black polyethylene core. Vinyl is 3M brand high performance vinyl with a 7-year warranty. Sign image on one side only. Sign vinyl is available in Brown, Green or Blue on a white background with image or type reversed.

Model No. – BROWN	Model No. – GREEN	Model No. – BLUE	Size	Optional Sign Posts Available	Wt. (lbs.)	Price
SN-M/W3-###	SN-M/N3-###	SN-M/U3-###	3" x 3" sq.	SN-PP44	1/2	\$32.00
SN-M/W9-###	SN-M/N9-###	SN-M/U9-###	9" x 9" sq.	SN-PP44, SN-PP66, SN-PFC/N-8, SN-PSO/N-8	1	\$46.00
SN-M/W12-###	SN-M/N12-###	SN-M/U12-###	12" x 12" sq.		1	\$60.00

Replace ### in the Model Nos. with the Symbol number of choice – see Catalog Pages 88 and 89 for the Symbol images and numbers.

POSTS for WAYFINDING and INFORMATIONAL SIGNS (Catalog Page 89)

Model No.	Size/Description	Signs Available	Wt. (lbs.)	Price
SN-PP/◆44-5	4" x 4" nom. sq. x 5 Ft. long Recycled Plastic Post	3" x 3", 9" x 9", and 12" x 12" sq.	22	\$123.00
SN-PP/◆44-6	4" x 4" nom. sq. x 6 Ft. long Recycled Plastic Post		27	\$148.00
SN-PP/◆44-8	4" x 4" nom. sq. x 8 Ft. long Recycled Plastic Post, embedded mount		36	\$194.00
SN-PP/◆66-8	6" x 6" nom. sq. x 8 Ft. long Recycled Plastic Post, embedded mount	9" x 9" and 12" x 12" sq.	78	\$343.00
SN-PP/44-MT/G	Optional Surface Mount Base Plate for 5 Ft. and 6 Ft. Sign Posts, Hot-Dip Galvanized finish (/G)		8	\$123.00
SN-PP/44-MT/CB	Optional Surface Mount Base Plate for 5 Ft. and 6 Ft. Sign Posts, *Black Powder Coated finish (/CB)			
SN-PFC/N-8	8 Ft. Fiberglass Post, closed channel, Green color, embedded mount	9" x 9" and 12" x 12" sq.	6	\$66.00
SN-PSO/N-8	8 Ft. Steel Post, open channel, Green baked on enamel finish, embedded mount		16	\$44.00
900-077	Fastener Package for Steel and Fiberglass Posts, (8) 5/16" x 2-1/2" zinc plated slotted machine screws and nuts		1	\$11.00

Replace ◆ in Model No. with the letter designations on Page 58 for *Recycled Plastic color choices.

*See Pages 57 – 59 for optional lumber species, material color options, and the character designators to specify those options in the Model Numbers.

BIKE RACKS

SAFETY BICYCLE RACK (Catalog Page 90)				Hot-Dip Galvanized finish only.		
Model No.	No. of Bikes	Sides Open	Size: Length x Width x Height	Wt. (lbs.)	Price	
BR-6DS	6	Double	4 Ft.: 47" x 20-1/4" x 12"	39	\$269.00	
BR-6SS	6	Single	8 Ft.: 95" x 20-1/4" x 12"	48	\$285.00	
BR-12DS	12	Double	8 Ft.: 95" x 20-1/4" x 12"	78	\$436.00	
BR-4HSA	Optional Set of (4) 3/8" x 1-7/8" hex sleeve anchors				\$10.00	



OMEGA BIKE RACK (Catalog Page 90)		1.90" O.D. Pipe	
Model No.	Size/Description	Wt. (lbs.)	Price
ORP/◆	36-3/4" wide, 32" high, mounts 2 bikes using both sides	18	\$208.00
Replace ◆ in Model No. with G for Galvanized finish or for *Powder Coated finish colors use the letter designations on Page 57.			
ANC3-6	Optional Set of (6) 3/8" x 3" heavy duty Concrete Screw Anchors	3	\$12.00

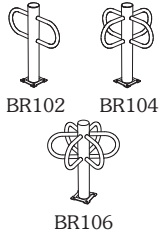

BOLLARD BIKE RACK (Catalog Page 91)		All-welded construction, 4-1/2" O.D. x 10 ga. wall steel tube Center Post, 1-1/2" O.D. steel tube Bike Loops, 1/4" x 8" square steel Base Plate		
Model No.	Size/Description	Wt. (lbs.)	Price	
BR102/◆	35" high, 28-1/4" wide, 2 Loops mount 2 bikes, *Powder Coated finish	29	\$267.00	
BR104/◆	35" high, 28-1/4" square, 4 Loops mount 4 bikes, *Powder Coated finish	36	\$308.00	
BR106/◆	35" high, 28-1/4" dia., 6 Loops mount 6 bikes, *Powder Coated finish	50	\$347.00	
Replace ◆ in Model No. with the letter designations on Page 57 for Powder Coated finish color choices.				
ANC1-4	Optional Set of (4) 1/2" x 3" heavy duty Concrete Screw Anchors	2	\$12.00	

HOOP BIKE RACK (Catalog Page 91)		1/4" x 2-1/2" steel plate Hoop, 1/4" x 8" square steel Base Plate, Thermo-plastic Coated finish		
Model No.	Size/Description	Wt. (lbs.)	Price	
BR20/◆	30" dia. x 34" high, mounts 2 bikes using both sides, Base Plate Surface Mount	33	\$216.00	
Replace ◆ in Model No. with the letter designations on Page 58 for *Thermo-plastic Coated finish colors.				
ANC1-4	Optional Set of (4) 1/2" x 3" heavy duty Concrete Screw Anchors	2	\$12.00	



VERTICAL BIKE RACK (Catalog Page 92)		1.66" O.D. x 10 ga. wall steel tube End Frames and Cross Tubes, 5/8" O.D. solid steel bar Vertical Stall Bars.									
Model No.	End Frame Style	Number of Bikes	Sides Open	Hot-Dip Galvanized Finish	Powder Coated Finish	Number of Sections	Length x Width x Height (in.)	Wt. (lbs.)	Price		
BR205SS/◆	"D"	5	Single Side	Yes	Yes	1	76" x 23" x 33"	105	\$399.00		
BR210SS/◆		10				2	150" x 23" x 33"	225	\$749.00		
BR210DS/◆	"Bell"	10	Double Side	Yes	Yes	1	76" x 46" x 33"	127	\$538.00		
BR220DS/◆		20				2	150" x 46" x 33"	232	\$983.00		
Replace ◆ in Model No. with G for Galvanized finish or for *Powder Coated finish colors use the letter designations on Page 57.											
Optional: a steel End Panel with Custom Laser Cut Signage may be bolted to one end or both ends of the BR210DS and BR220DS "Bell" Style Bike Racks - inquire for details and prices											
ANC2-4	Optional Set of (4) 3/8" x 5" heavy duty Concrete Screw Anchors, for 1- and 2-section "D" Racks and 1-section "Bell" Racks							2	\$11.00		
ANC2-6	Optional Set of (6) 3/8" x 5" heavy duty Concrete Screw Anchors, for 2-section "Bell" Rack							3	\$15.00		



"WHEEL" STYLE VERTICAL BIKE RACK (Catalog Page 93)		1.66" O.D. x 10 ga. wall steel tube End Frames and Cross Tubes, 5/8" O.D. solid steel bar Vertical Stall Bars									
Model No.	"Wheel" Style	Number of Bikes	Sides Open	Hot-Dip Galvanized Finish	Powder Coated Finish	Number of Sections	Length x Width x Height (in.)	Wt. (lbs.)	Price		
BR310DS/◆	"Wheel"	10	Double Side	No	Yes	1	80" x 33" x 33"	155	\$1,073.00		
BR320DS/◆		20				2	153" x 33" x 33"	274	\$1,844.00		
Replace ◆ in Model No. with G for Galvanized finish or for *Powder Coated finish colors use the letter designations on Page 57.											
ANC3-4	Optional Set of (4) 3/8" x 3" heavy duty Concrete Screw Anchors, for 1-section "Wheel" Racks							2	\$10.00		
ANC3-6	Optional Set of (6) 3/8" x 3" heavy duty Concrete Screw Anchors, for 2-section "Wheel" Racks							3	\$12.00		



STEEL WHEELS BIKE RACKS (Catalog Page 93)		All-welded construction, 1.66" O.D. x 10 ga. wall steel tube Frame, 1-3/4" x 1-3/4" x 3/16" x 5" steel angle Base Brackets		
Model No.	Size/Description	Wt. (lbs.)	Price	
BR30/◆	41" high, 5-1/2" wide, 50" long, mounts 2 bikes, *Powder Coated finish	38	\$502.00	
BR31/◆	45" high, 5-1/2" wide, 76" long, mounts 2-4 bikes, *Powder Coated finish	52	\$532.00	
Replace ◆ in Model No. with the letter designations on Page 57 for *Powder Coated finish color choices.				
ANC1-4	Optional Set of (4) 1/2" x 3" heavy duty Concrete Screw Anchors, (2) Sets required.	2	\$12.00	

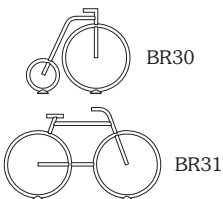

*See Pages 57 - 59 for optional lumber species, material color options, and the character designators to specify those options in the Model Numbers.

RJ Thomas Mfg. Co., Inc.

P.O. Box 946 • Cherokee, Iowa 51012-0946 • ORDERS Toll Free: 800-762-5002 • FAX: 712-225-5796 • 712-225-5115

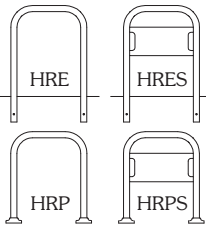

HITCHIN' POST BIKE RACK (Catalog Page 94)							
2-3/8" O.D. Steel Pipe frame. **Models HRES/◆ and HRPS/◆ include optional Sign Plates: Custom Decals are available – see below (Not available with Thermo-plastic Coating); Custom Laser Cut Designs in the steel Sign Plate are available – inquire for details and prices.							
Model No.	Number of Bikes	Installation Method	Width (in.)	Length (in.)	Optional Anchor Kit (Concrete Screw Anchors)	Wt. (lbs.)	Price
HRE/◆	2	Embedded Post Mount	29-3/8	NA	NA	33	\$162.00
**HRES/◆						43	\$212.00
HRP/◆	2	Base Plate Surface Mount. 2-part Cover Caps included - Galvanized or Powder Coat finish only	33	NA	ANC3-4: (4) 3/8" x 3"	34	\$172.00
**HRPS/◆						39	\$224.00
**SIGN HR10X20	Set of (2) Custom Vinyl Decals for Sign Plate on Models HRES and HRPS; maximum size: 10-1/2" x 20"						\$117.00
Replace ◆ in Model No. with G for Galvanized finish or for *Powder Coated finish colors or *Thermo-plastic Coated colors use the letter designations on Pages 57 and 58. Thermo-plastic Coating not available for Sign Plate models using Custom Vinyl Decals.							
Model No.	Size/Description					Wt. (lbs.)	Price
ANC3-4	Optional Set of (4) 3/8" x 3" heavy duty Concrete Screw Anchors					2	\$10.00
Optional 2-part Cover Caps (Catalog Pages 26 & 94)							Add to the Bike Rack Price
For Model HRE embedded post mount Bike Racks – Galvanized or *Powder Coated finish. Not available with Model HRE or HRP Bike Racks with Thermo-plastic Coating.							
Set of (2) 2-part Cover Caps for HRE models. Add /C to the end of the Bike Rack model number.							\$74.00

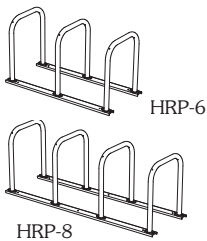
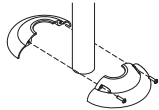

HITCHIN' POST GROUP BIKE RACK (Catalog Page 94)							
2-3/8" O.D. Steel Pipe frame, welded-on base plates bolt to 1" x 4" nom. x 10 ga. formed steel base channels.							
Model No.	Number of Bikes	Installation Method	Width (in.)	Length (in.)	Optional Anchor Kit (Concrete Screw Anchors)	Wt. (lbs.)	Price
HRP/◆-6	6	Group Rack, Base Channel Surface Mount	31-1/4	66	ANC2-4: (4) 3/8" x 5"	137	\$574.00
HRP/◆-8	8			96	ANC2-6: (6) 3/8" x 5"	165	\$754.00
Replace ◆ in Model No. with G for Galvanized finish or for *Powder Coated finish colors use the letter designations on Page 57. Thermo-plastic Coating not available.							
Model No.	Size/Description					Wt. (lbs.)	Price
ANC2-4	Optional Set of (4) 3/8" x 5" heavy duty Concrete Screw Anchors					2	\$11.00
ANC2-6	Optional Set of (6) 3/8" x 5" heavy duty Concrete Screw Anchors					3	\$15.00

SADDLEBACK BIKE RACK (Catalog Page 95)				2-3/8" O.D. Schl. 40 Pipe frame			
Model No.	Length (in.)	Number of Bikes	Installation Method	Optional Anchor Kit (Concrete Screw Anchors)		Wt. (lbs.)	Price
SRE/◆-3	14	3	Embedded Post Mount	NA		23	\$218.00
SRE/◆-5	38	5		NA		46	\$431.00
SRE/◆-7	62	7		NA		60	\$557.00
SRE/◆-9	86	9		NA		98	\$683.00
SRE/◆-11	110	11		NA		120	\$825.00
SRE/◆-13	134	13		NA		153	\$1,001.00
SRP/◆-3	14	3	Base Plate Surface Mount 2-part Cover Caps included	ANC3-4: (4) 3/8" x 3"		29	\$285.00
SRP/◆-5	38	5		ANC3-4: (4) 3/8" x 3"		53	\$500.00
SRP/◆-7	62	7		ANC3-4: (4) 3/8" x 3"		63	\$623.00
SRP/◆-9	86	9		ANC3-4: (4) 3/8" x 3"		101	\$749.00
SRP/◆-11	110	11		ANC3-4: (4) 3/8" x 3"		123	\$892.00
SRP/◆-13	134	13		ANC3-6: (6) 3/8" x 3"		156	\$1,102.00
Replace ◆ in Model No. with G for Galvanized finish or for *Powder Coated finish colors use the letter designations on Page 57.							
ANC3-4	Optional Set of (4) 3/8" x 3" heavy duty Concrete Screw Anchors for SRP-3 – SRP-11 models.					2	\$10.00
ANC3-6	Optional Set of (6) 3/8" x 3" heavy duty Concrete Screw Anchors for SRP-13 model.					3	\$12.00
Optional 2-part Cover Caps (Catalog Pages 26 & 95)							Add to the Bike Rack Price
Optional for Model SRE embedded post mount Bike Racks – Galvanized or *Powder Coated finish.							
Set of (2) 2-part Cover Caps for SRE-3 – SRE-11 models. Add /C to the end of the Bike Rack model number.							\$74.00
Set of (3) 2-part Cover Caps for SRE-13 model. Add /C to the end of the Bike Rack model number							\$111.00

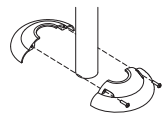
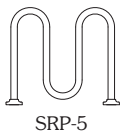
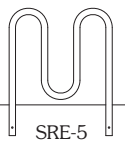

*See Pages 57 – 59 for optional lumber species, material color options, and the character designators to specify those options in the Model Numbers.

PARK GRILLS



Model No.		Finish	Firebox Size (D x W x H)	Grate Qty.	Total Cooking Area (sq. in.)	Wt. (lbs.) -no shelf	Price
ASW-20 B2		high temp, non-toxic Black Enamel paint	15" x 20" x 6" (swivel side) - 10" (other side)	1	300	76	\$273.00
ASWS-20 B6S		Stainless Steel box, grate, and post base	15" x 20" x 6" (swivel side) - 10" (other side)	1	300	60	\$849.00
ASW-24 B2		high temp, non-toxic Black Enamel paint	15" x 24" x 6" (swivel side) - 10" (other side)	1	360	86	\$307.00
ASWS-24 B6S		Stainless Steel box, grate, and post base	15" x 24" x 6" (swivel side) - 10" (other side)	1	360	70	\$883.00

Optional Bases for ASW Series Accessible Grills			Add to Grill Price
Model No.	Style	Wt. (lbs.)	
B18	Black Enamel Surface Mount Base Plate	14	\$25.00
B19S	Stainless Steel Surface Mount Base Plate	10	\$49.00

Optional Shelves for ASW Series Accessible Grills					
Model No.	Fits on	Finish	Size (in.)	Wt. (lbs.)	Price
S6 Swivel Shelf	ASW-20, ASW-24	Black Enamel Paint	8 x 16	16	\$92.00

Model No.		Finish	Firebox Size (D x W x H)	Grate Qty.	Total Cooking Area (sq. in.)	Wt. (lbs.) -no shelf	Price
A-20 B2		high temp, non-toxic Black Enamel paint	16" x 20" x 8"	1	320	83	\$313.00
B-24 B2		high temp, non-toxic Black Enamel paint	16" x 24" x 8"	1	384	91	\$343.00
C2-36 B2		high temp, non-toxic Black Enamel paint	(2) 16" x 20" x 8"	2	640	145	\$545.00
D2-48 B2		high temp, non-toxic Black Enamel paint	32" x 32-1/2" x 8"	2	1040	214	\$803.00

Optional Shelves for Premier Park Grills					
Model No.	Fits on	Finish	Size (in.)	Wt. (lbs.)	Price
S1	A-20, B-24, C2-36 (1 or 2)	Black Enamel Paint	7-1/8 x 9-5/8	4	\$24.00
S2	D2-48 (1 or 2)		9 x 20	9	\$33.00
S6 Swivel Shelf	A-20, B-24		8 x 16	16	\$92.00

Optional Bases for Premier Park Grills				Add to Grill Price
Model No.	Style	Fits on	Wt. (lbs.)	
B3	Surface Mount Base Plate	A-20, B-24, C2-36, D2-48	14	\$30.00
B4	Portable Disc Base	C2-36, D2-48	27	\$113.00
B14	Portable Caster Base	C2-36, D2-48	33	\$209.00

Model No.		Finish	Firebox Size (D x W x H)	Grate Qty.	Total Cooking Area (sq. in.)	Wt. (lbs.) -no shelf	Price
N-20 B2		high temp, non-toxic Black Enamel paint	15" x 20" x 10"	1	300	80	\$280.00
N/G-20 B2G		Hot-Dip Galvanized box, Pre Galvanized post, Black Enamel grate	15" x 20" x 10"	1	300	81	\$370.00
NS-20 B6S		Stainless Steel box and post base, Black Enamel grate	15" x 20" x 10"	1	300	63	\$608.00
N-24 B2		high temp, non-toxic Black Enamel paint	18" x 24" x 10"	1	432	108	\$377.00
N/G-24 B2G		Hot-Dip Galvanized box, Pre Galvanized post, Black Enamel grate	18" x 24" x 10"	1	432	109	\$476.00

Optional Shelves for N Series Multilevel Grills					
Model No.	Fits on	Finish	Size (in.)	Wt. (lbs.)	Price
S3	N-20, N-24	Black Enamel Paint	7 x 20	7	\$27.00
S3/G	N/G-20, N/G-24			Hot-Dip Galvanized	8
S3S	NS-20	Stainless Steel	7 x 19-1/4	7	\$84.00
S6 Swivel Shelf	N-20, N/G-20, N-24, N/G-24	Black Enamel Paint	8 x 16	16	\$92.00

Other Options for N Series Multilevel Grills				
Model No.	Fits on	Finish	Wt. (lbs.)	Price
Hot Plate Grate (/HP)	N-20, N/G-20	Black Enamel Paint	16	\$57.00
Stainless Steel Grate (Models change to: N/S-20, N/G/S-20, or NS/S-20)	N-20, N/G-20, NS-20	Stainless Steel	22	\$247.00
Model GC/B-1 Grill Cover	N-20	Black Enamel Paint	15	\$92.00
Model GC/G-1 Grill Cover	N-20, N/G-20, NS-20	Hot-Dip Galvanized	16	\$130.00
Model GC/B-2 Grill Cover	N-24	Black Enamel Paint	20	\$121.00
Model GC/G-2 Grill Cover	N-24, N/G-24	Hot-Dip Galvanized	21	\$176.00

Optional Bases for N Series Multilevel Grills				Add to Grill Price
Model No.	Style	Fits on	Wt. (lbs.)	
B3	Surface Mount Base Plate	N-20, N/G-20, N-24, N/G-24	14	\$30.00
B4	Portable Disc Base	N-24, N/G-24	27	\$113.00
B3G	Hot-Dip Galvanized Surface Mount Base Plate	N/G-20, N/G-24	15	\$39.00
B17S	Stainless Steel Surface Mount Base Plate	NS-20	11	\$49.00

*See Pages 57 – 59 for optional lumber species, material color options, and the character designators to specify those options in the Model Numbers.

RJ Thomas Mfg. Co., Inc.

P.O. Box 946 • Cherokee, Iowa 51012-0946 • ORDERS Toll Free: 800-762-5002 • FAX: 712-225-5796 • 712-225-5115

 MULTILEVEL GRILLS - Q Series (Catalog Page 102)		Four level adjustable Cooking Grates, grate tips back inside reinforced firebox, full 360 degree rotation of firebox on theft proof base attachment, standard with B2 (3-1/2" O.D.) embedded Post Base				
Model No.	Finish	Firebox Size (D x W x H)	Grate Qty	Total Cooking Area (sq. in.)	Wt. (lbs.) -no shelf	Price
Q-20 B2	high temp, non-toxic Black Enamel paint	15" x 20" x 10"	1	300	80	\$288.00
Q/G-20 B2G	Hot-Dip Galvanized box, Pre Galvanized post, Black Enamel grate	15" x 20" x 10"	1	300	81	\$376.00
Q-24 B2	high temp, non-toxic Black Enamel paint	18" x 24" x 10"	1	432	108	\$387.00
Q/G-24 B2G	Hot-Dip Galvanized box, Pre Galvanized post, Black Enamel grate	18" x 24" x 10"	1	432	109	\$482.00

Optional Shelves for Q Series Multilevel Grills					
Model No.	Fits on	Finish	Size (in.)	Wt. (lbs.)	Price
S3	Q-20, Q-24	Black Enamel Paint	7 x 20	7	\$27.00
S3/G	Q/G-20, Q/G-24	Hot-Dip Galvanized		8	\$33.00
S6 Swivel Shelf	Q-20, Q/G-20, Q-24, Q/G-24	Black Enamel Paint	8 x 16	16	\$92.00

Other Options for Q Series Multilevel Grills				
Model No.	Fits on	Finish	Wt. (lbs.)	Price
Stainless Steel Grate (Models change to: Q/S-20 or Q/G/S-20)	Q-20, Q/G-20	Stainless Steel	22	\$247.00
Model GC/B-1 Grill Cover	Q-20	Black Enamel Paint	15	\$92.00
Model GC/G-1 Grill Cover	Q-20, Q/G-20	Hot-Dip Galvanized	16	\$130.00
Model GC/B-2 Grill Cover	Q-24	Black Enamel Paint	20	\$121.00
Model GC/G-2 Grill Cover	Q-24, Q/G-24	Hot-Dip Galvanized	21	\$176.00

Optional Bases for Q Series Multilevel Grills				
Model No.	Style	Fits on	Wt. (lbs.)	Add to Grill Price
B3	Surface Mount Base Plate	Q-20, Q/G-20, Q-24, Q/G-24	14	\$30.00
B4	Portable Disc Base	Q-20, Q/G-20, Q-24, Q/G-24	27	\$113.00
B3G	Hot-Dip Galvanized Surface Mount Base Plate	Q/G-20, Q/G-24	15	\$39.00

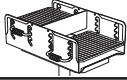
 DOUBLE MULTILEVEL GRILL - N2-2032 Series (Catalog Page 103)		(2) back-to-back four level adjustable Cooking Grates, reinforced firebox, full 360 degree rotation of firebox on theft proof base attachment, standard with B2 (3-1/2" O.D.) embedded Post Base				
Model No.	Finish	Firebox Size (D x W x H)	Grate Qty.	Total Cooking Area (sq. in.)	Wt. (lbs.) -no shelf	Price
N2-2032 B2	high temp, non-toxic Black Enamel paint	(2) 15" x 20" x 10"	2	600	141	\$502.00

Optional Shelves for N2-2032 Series Multilevel Grills -order Shelves separately from the Grill				
Model No.	Finish	Size (in.)	Wt. (lbs.)	Price
S1 (1 or 2)	Black Enamel Paint	7-1/8 x 9-5/8	4	\$24.00
S2 (1)		9 x 20	9	\$33.00

Optional Bases for N2-2032 Series Multilevel Grills				Add to Grill Price
Model No.	Style	Fits on	Wt. (lbs.)	Price
B3	Surface Mount Base Plate		14	\$30.00
B4	Portable Disc Base		27	\$113.00
B14	Portable Caster Base		33	\$209.00

Other Options for N2-2032 Series Multilevel Grills			
Model No.	Finish	Wt. (lbs.)	Price
Stainless Steel Grates (2) (Model changes to: N2/SS-2032)	Stainless Steel	44	\$493.00



 MULTILEVEL GRILLS -H, J, & K Series (Catalog Page 104)		Four level adjustable Cooking Grate, grate tips back inside reinforced firebox, full 360 degree rotation of firebox on theft proof base attachment, standard with B2 (3-1/2" O.D.) embedded Post Base except for Model H-16 B6 which has a 2-3/8" O.D. embedded Post Base				
Model No.	Finish	Firebox Size (D x W x H)	Grate Qty	Total Cooking Area (sq. in.)	Wt. (lbs.) -no shelf	Price
H-16 B6	high temp, non-toxic Black Enamel paint	16" x 16" x 8"	1	250	61	\$217.00
J-20 B2	high temp, non-toxic Black Enamel paint	15" x 20" x 8"	1	300	75	\$269.00
K-20 B2	high temp, non-toxic Black Enamel paint	15" x 20" x 10"	1	300	83	\$290.00

Optional Shelves for J or K Series Multilevel Grills					
Model No.	Fits on	Finish	Size (in.)	Wt. (lbs.)	Price
S3	K-20	Black Enamel Paint	7 x 20	7	\$27.00
S6 Swivel Shelf	J-20, K-20	Black Enamel Paint	8 x 16	16	\$92.00

Optional Bases for H, J, or K Series Multilevel Grills				Add to Grill Price
Model No.	Style	Fits on	Wt. (lbs.)	Price
B3	Surface Mount Base Plate	J-20, K-20	14	\$30.00
B4	Portable Disc Base		27	\$113.00
B6	2-3/8" O.D. embedded Post Base	J-20	9	\$25.00
B17	Surface Mount Base Plate	H-16, J-20	11	\$25.00

Other Options for J or K Series Multilevel Grills				
Model No.	Fits on	Finish	Wt. (lbs.)	Price
Model GC/B-1 Grill Cover	K-20	Black Enamel Paint	15	\$92.00
Hot Plate Grate (/HP)	J-20, K-20	Black Enamel Paint	16	\$57.00



*See Pages 57 – 59 for optional lumber species, material color options, and the character designators to specify those options in the Model Numbers.

				COVERED GRILLS - EC Series (Catalog Page 105)			
One level tip-back Cooking Grate, (1) tip-back Fire Grate, reinforced firebox, full 360 degree rotation of firebox on theft proof base attachment, (1) S2 Shelf and B2 (3-1/2" O.D.) embedded Post Base							
Model No.	Finish	Overall Size without shelf (D x W x H)	Grate Qty	Total Cooking Area (sq. in.)	Wt. (lbs.)	Price	
EC-26/S B2	high temp, non-toxic Black Enamel paint	19-1/2" x 29-1/4" x 16-1/2"	(1) cooking	320	137	\$704.00	
EC-40/S B2	high temp, non-toxic Black Enamel paint	19-1/2" x 41-1/2" x 16-1/2"	(1) cooking	500	178	\$920.00	

Optional Shelves for Covered Grills					
Model No.	Fits on	Finish	Size (in.)	Wt. (lbs.)	Price
S6 Swivel Shelf	EC-26	Black Enamel Paint	8 x 16	16	\$92.00

Optional Bases for Covered Grills				Add to Grill Price
Model No.	Style	Fits on	Wt. (lbs.)	
B3	Surface Mount Base Plate	EC-26, EC-40	14	\$30.00
B4	Portable Disc Base	EC-26, EC-40	27	\$113.00
B12	2-Wheel Portable Caster Base	EC-26, EC-40	26	\$131.00
B14	4-Wheel Portable Caster Base	EC-26, EC-40	33	\$209.00

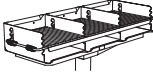
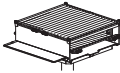
Other Options for Covered Grills					
Model No.	Fits on	Size (in.)	Wt. (lbs.)	Price	
ECB-26 Warming Basket	EC-26	7 x 21 x 2 deep	4	\$62.00	
ECB-40 Warming Basket	EC-40	7 x 33 x 2 deep	9	\$76.00	

						LARGE GROUP GRILLS - Q3, L, & P Series (Catalog Pages 106 & 107)	
Four level adjustable Cooking Grates or Fire Grates, reinforced firebox, full 360 degree rotation of firebox on theft proof base attachment, standard with surface mount base plate post installation, (4) 1/2" x 6" J-bolt anchors for concrete footing included, finished in high temp, non-toxic Black Enamel paint							
Model No.	Firebox Size (D x W x H)	Overall Size (D x W x H)	Cooking Area (sq. in.)	Wt. (lbs.)	Price		
Q3-2460 B8	24" x 60" x 10"	24" x 60" x 10"	1220 (adjustable Grate with 3 Cooking Grate Surfaces)	289 (No Shelf)	\$1,162.00		
L-1500/S B8	36" x 38" x 12"	36" x 38" x 12"	1350 (2 tip-back, single level Cooking Grates, 1 adjustable Fire Grate)	430 (1 Shelf included)	\$1,419.00		
P-1000/S B7	28" x 36" x 10"	28" x 36" x 10"	1008 (2 adjustable Cooking Grates)	215 (1 Shelf included)	\$791.00		

Optional Shelves for Large Group Grills				
Model No.	Fits on	Size (in.)	Wt. (lbs.)	Price
S1	P-1000 (1 or 2)	7-1/8 x 9-5/8	4	\$24.00
S2	P-1000 (1 or 2)	9 x 20	9	\$33.00
S4	L-1500, P-1000 (1 additional)	10-5/8 x 36	25	\$86.00
S7	Q3-2460	10-5/8 x 59	37	\$128.00

Optional Bases for Large Group Grills				Add to Grill Price
Model No.	Style	Fits on	Wt. (lbs.)	
B11	Portable Caster Base	L-1500	43	\$216.00
B13	Embedded Base	P-1000	18	\$40.00
B15	Portable Caster Base	P-1000	37	\$212.00
B16	Embedded Base	L-1500, Q3-2460	26	\$52.00

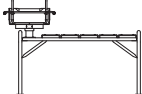
	GRILL STATION (Catalog Page 108)				
1-5/8" O.D. steel pipe frames (1.66" O.D., 10 ga. wall, 1-1/4" I.D. nom. pipe specifications) with surface mount flanges, concrete Anchors included, 1-1/2" x 1-1/2" x 1/8" structural steel angle top frame, 1-5/16" O.D. steel pipe diagonal braces, (5) 2" x 10" (nom.) x 20" top planks, and (1) grill mount with theft proof swivel attachment that allows grill to rotate 360 degrees. Grill sold separately (see below).					
Powder Coated Frames, Black standard * (V/CB) Model No.	Hot-Dip Galvanized Frames (G) Model No.	Size (in.)	Table Top Material	Wt. (lbs.)	Price
GS/CB-5UP	GS/G-5UP	22-1/2" wide x 64" long x 30-1/2" high (nom. overall outside dimensions without the grill) 36" Grill height to bottom of firebox.	*Untreated #1 Southern Yellow Pine	99	\$279.00
GS/CB-5TP	GS/G-5TP		*Treated #1 Southern Yellow Pine	99	\$284.00
GS/CB-5PC	GS/G-5PC		*Cedar colored Recycled Plastic	113	\$417.00
GS/CB-5AL	GS/G-5AL		Clear Anodized Aluminum	88	\$426.00
GS/CB-5AR	GS/G-5AR		*Red Powder Coated Aluminum	88	\$426.00
CC-1 1 Optional bolt-together Cast Aluminum Cover Cap (2 Halves); no coating, with fasteners - see Page 13				1	\$37.00
CC/CB-1 1 Optional bolt-together Cast Aluminum Cover Cap (2 Halves); *Powder Coated Black (V/CB), with fasteners - see Page 13					

GRILLS for the GRILL STATION				Model No.	Cooking Area	Wt. (lbs.)	Price	Model No.	Cooking Area	Wt. (lbs.)	Price
Model No.	Cooking Area	Wt. (lbs.)	Price	B-24-2	384 sq. in.	75	\$291.00	N-20-2	300 sq. in.	64	\$228.00
A-20-2	320 sq. in.	67	\$261.00	EC-26/S-2	320 sq. in.	128	\$654.00	N-24-2	432 sq. in.	92	\$326.00
ASW-20-2	300 sq. in.	60	\$223.00	J-20-2	300 sq. in.	59	\$217.00	Q-20-2	300 sq. in.	64	\$236.00
ASW-24-2	360 sq. in.	68	\$256.00	K-20-2	300 sq. in.	67	\$238.00	Q-24-2	432 sq. in.	92	\$335.00

HOT COAL BIN (Catalog Page 109)		23" x 23" x 32-1/2" high, 1/16" (14 ga.) steel panels, door and top, 1/2" dia. steel grate bars, (2) "Caution" decals			
Model No.	Finish	Wt. (lbs.)	Price		
HCB/B-1	Entire unit: high temp Black Enamel paint	88	\$513.00		
HCB/CB-1	Side panels and door: *Powder Coated Black paint; Top and grate: high temp Black Enamel paint		\$674.00		

Hot Coal Bin Options			
Model No.	Description	Wt. (lbs.)	Price
HCB-1C	<i>New!</i> Hot Coal Bin Cover, 22-7/8" x 22-7/8" 16 ga. pre-galvanized steel with handle	12	\$165.00
HCB-1C/CB	<i>New!</i> Hot Coal Bin Cover, 22-7/8" x 22-7/8" 16 ga. steel with handle, *Powder Coated Black paint finish	12	\$165.00
PL-1	Padlock, Precision Brass Tumbler and Case, keyed alike, 2-1/2" overall		\$12.00
CNG-2310C	31 Gal. Can, Pregalvanized sheet steel, 27 Ga. can, without lid	10	\$89.00
M9/B	Ground Anchors, set of 3 steel rods to install through holes in Base Flanges, Black Enamel paint finish	3	\$20.00
BR-4HSA	Concrete Anchors; 1 set of (4) 3/8" x 1-7/8" hex sleeve anchors		\$10.00
GGs/B-1	Grill and Grate Scraper, coil spring grip, Black Enamel paint finish	2	\$18.00
CNG-W10120	12 Quart, galvanized steel collection pail	3	\$29.00

*See Pages 57 - 59 for optional lumber species, material color options, and the character designators to specify those options in the Model Numbers.

RJ Thomas Mfg. Co., Inc.

P.O. Box 946 • Cherokee, Iowa 51012-0946 • **ORDERS Toll Free: 800-762-5002** • FAX: 712-225-5796 • 712-225-5115

CAMPFIRE RINGS

	CAMPFIRE RINGS ONLY - NO GRATE - FX Series (Catalog Page 112)				Flanged 3/16" plate steel firering, 1" flanged top edge, finished in high temp, non-toxic Black Enamel paint								
	Model No.	Outside Diameter (in.)	Inside Diameter (in.)	Side Height (in.)	Cooking Area (sq. in.)	Standard: (2) Tip-Back "U" Anchor Pins (TB)		Optional: (3) welded-on Angle Spade Anchors (AL)		Optional: (2) Angle Spade Tip-Back Anchors (TA)		Optional: (1) Tip Back-Bolt Down Anchor Bracket (TB-BD) (FX-30 only)	
						Wt. (lbs.)	Price	Wt. (lbs.)	Price	Wt. (lbs.)	Price	Wt. (lbs.)	Price
FX-26/7/◆	26	24	7-3/8	NA -No Cooking Grate	39	\$162.00	48	\$193.00	46	\$189.00	NA		
FX-30/7/◆	32	30	7-3/8		44	\$179.00	53	\$209.00	51	\$205.00	44	\$179.00	
FX-30/9/◆	32	30	9		58	\$228.00	67	\$259.00	65	\$255.00	58	\$228.00	
FX-30/11/◆	32	30	11-3/8		66	\$258.00	75	\$289.00	73	\$284.00	66	\$258.00	

Replace ◆ in Model No. with TB for Standard (2) "U" Anchor Pins, AL for optional (3) Angle Spade Anchors, TA for Optional (2) Angle Spade Tip-Back Anchors, or TB-BD for a Tip Back-Bolt Down Anchor Bracket (FX-30 rings only).

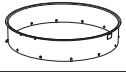
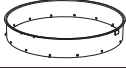
	Model No.	Outside Diameter (in.)	Inside Diameter (in.)	Side Height (in.)	Cooking Area (sq. in.)	Standard: (4) "U" Anchor Pins (PA)		Optional: (4) Angle Spade Anchors (AL)	
						Wt. (lbs.)	Price	Wt. (lbs.)	Price
						NA -No Cooking Grate	FX-48/7/▼	48	46
FX-48/9/▼	9	79	\$339.00	83	\$383.00				
FX-48/11/▼	11-3/8	97	\$432.00	101	\$476.00				
	FX-56/7/▼	56	54	7-3/8	79	\$344.00	83	\$388.00	
	FX-56/9/▼			9	93	\$410.00	97	\$454.00	
	FX-56/11/▼			11-3/8	114	\$476.00	118	\$520.00	

Replace ▼ in Model No. with PA for Standard (4) "U" Anchor Pins or AL for optional (4) Angle Spade Anchors.

	Model No.	Outside Diameter (in.)	Inside Diameter (in.)	Side Height (in.)	Cooking Area (sq. in.)	Standard: (3) "U" Anchor Pins (PA)		Optional: (3) Angle Spade Anchors (AL)	
						Wt. (lbs.)	Price	Wt. (lbs.)	Price
						FX-30/18/▲	32	30	16-7/8

Replace ▲ in Model No. with PA for Standard (3) "U" Anchor Pins or AL for optional (3) Angle Spade Anchors.

	CAMPFIRE RINGS - FA Series (Catalog Page 113)				The Original Infinitely Adjustable Cooking Grate. flanged 3/16" plate steel firering, 1" flanged top edge, cantilevered structurally reinforced grate tips back out of firering but remains attached, finished in high temp, non-toxic Black Enamel paint									
	Model No.	Outside Diameter (in.)	Inside Diameter (in.)	Side Height (in.)	Cooking Area (sq. in.)	Vertical Grate Adjustment (in.)	Standard: (2) Tip-Back "U" Anchor Pins (TB)		Optional: (3) welded-on Angle Spade Anchors (AL)		Optional: (2) Angle Spade Tip-Back Anchors (TA)		Optional: (1) Tip Back-Bolt Down Anchor Bracket (TB-BD) (FA-30 only)	
							Wt. (lbs.)	Price	Wt. (lbs.)	Price	Wt. (lbs.)	Price	Wt. (lbs.)	Price
FA-26/7/*	26	24	7-3/8	270	7-3/4	68	\$242.00	77	\$273.00	75	\$269.00	NA		
FA-30/7/*	32	30	7-3/8			76	\$271.00	85	\$302.00	83	\$297.00	76	\$271.00	
FA-30/9/*	32	30	9			90	\$322.00	99	\$352.00	97	\$348.00	90	\$322.00	
FA-30/11/*	32	30	11-3/8			98	\$348.00	107	\$379.00	105	\$374.00	98	\$348.00	

Replace * in Model No. with TB for Standard (2) "U" Anchor Pins, AL for optional (3) Angle Spade Anchors, TA for Optional (2) Angle Spade Tip-Back Anchors, or TB-BD for a Tip Back-Bolt Down Anchor Bracket (FA-30 rings only).

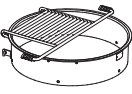

	Model No.	Outside Diameter (in.)	Inside Diameter (in.)	Side Height (in.)	Cooking Area (sq. in.)	Vertical Grate Adjustment (in.)	Standard: (3) "U" Anchor Pins (PA)		Optional: (3) Angle Spade Anchors (AL)	
							Wt. (lbs.)	Price	Wt. (lbs.)	Price
							FA-30/18/●	32	30	16-7/8

Replace ● in Model No. with PA for Standard (3) "U" Anchor Pins or AL for optional (3) Angle Spade Anchors.

	CAMPFIRE RINGS - FS Series (Catalog Page 114)				Single Level Cooking Grate. flanged 3/16" plate steel firering, 1" flanged top edge, grate tips back out of firering and is permanently attached, high temp, non-toxic Black Enamel paint finish									
	Model No.	Outside Diameter (in.)	Inside Diameter (in.)	Side Height (in.)	Cooking Area (sq. in.)	Grate Adjustment	Standard: (2) Tip-Back "U" Anchor Pins (TB)		Optional: (3) welded-on Angle Spade Anchors (AL)		Optional: (2) Angle Spade Tip-Back Anchors (TA)		Optional: (1) Tip Back-Bolt Down Anchor Bracket (TB-BD) (FS-30 only)	
							Wt. (lbs.)	Price	Wt. (lbs.)	Price	Wt. (lbs.)	Price	Wt. (lbs.)	Price
FS-26/7/◆	26	24	7-3/8	290	One Level, tip-over	60	\$216.00	69	\$247.00	67	\$242.00	NA		
FS-30/7/◆	32	30	7-3/8			66	\$236.00	75	\$267.00	73	\$262.00	66	\$236.00	
FS-30/9/◆	32	30	9			80	\$286.00	89	\$317.00	87	\$313.00	80	\$286.00	
FS-30/11/◆	32	30	11-3/8			88	\$314.00	97	\$345.00	95	\$340.00	88	\$314.00	

Replace ◆ in Model No. with TB for Standard (2) "U" Anchor Pins, AL for optional (3) Angle Spade Anchors, TA for Optional (2) Angle Spade Tip-Back Anchors, or TB-BD for a Tip Back-Bolt Down Anchor Bracket (FS-30 rings only).

CAMPFIRE RINGS - FS Series ... continued on Page 53

CAMPFIRE RINGS - FS Series (Catalog Page 114) ...continued										
Single Level Cooking Grate, flanged 3/16" plate steel firering, 1" flanged top edge, grate tips back out of firering and is permanently attached, high temp, non-toxic Black Enamel paint finish										
Large Campfire Rings	Model No.	Outside Diameter (in.)	Inside Diameter (in.)	Side Height (in.)	Cooking Area (sq. in.)	Grate Adjustment	Standard: (4) "U" Anchor Pins (PA)		Optional: (4) Angle Spade Anchors (AL)	
							Wt. (lbs.)	Price	Wt. (lbs.)	Price
	FS-48/7/❖	48	46	7-3/8	290	One Level, tip-over	99	\$355.00	111	\$399.00
	FS-48/9/❖			9			115	\$410.00	127	\$454.00
	FS-48/11/❖			11-3/8			142	\$502.00	154	\$546.00
	FS-56/7/❖	56	54	7-3/8			118	\$422.00	130	\$466.00
	FS-56/9/❖			9			137	\$487.00	149	\$531.00
	FS-56/11/❖			11-3/8			156	\$553.00	168	\$597.00

Replace ❖ in Model No. with PA for Standard (4) "U" Anchor Pins or AL for optional (4) Angle Spade Anchors.

CAMPFIRE RINGS with SWIVEL GRATES - FSW Series (Catalog Page 115)								
Single Level Swivel Cooking Grate meets ADA guidelines for one hand operation requiring less than 5 lbs. of force to move. Grate rotates 180° out of firering with handle never over the fire. Finished in high temp, non-toxic Black Enamel paint.								
Model No.	Outside Diameter (in.)	Inside Diameter (in.)	Side Height (in.)	Swivel Grate Cooking Area (sq. in.)	Heat Shield Available	Anchor System	Wt. (lbs.)	Price
FSW-26/7/TB	26	24	7-3/8	300	No	(2) Tip-Back "U" Anchor Pins (TB) (Optional: AL or TA) (Optional: TB-BD for FSW-30 only)	59	\$223.00
FSW-30/7/TB	32	30	7-3/8	300	No		64	\$242.00
FSW-30/9/TB	32	30	9		74		\$291.00	
FSW-30/11/TB	32	30	11-3/8	300	Yes	(4) "U" Anchor Pins (PA) (Optional: AL)	83	\$322.00
FSW-48/7/PA	48	46	7-3/8		No		91	\$359.00
FSW-48/9/PA	48	46	9	300	No	(4) "U" Anchor Pins (PA) (Optional: AL)	103	\$414.00
FSW-48/11/PA	48	46	11-3/8				121	\$511.00
FSW-56/7/PA	56	54	7-3/8	300	No	(4) "U" Anchor Pins (PA) (Optional: AL)	103	\$427.00
FSW-56/9/PA	56	54	9				117	\$492.00
FSW-56/11/PA	56	54	11-3/8				138	\$558.00

Anchor: For the AL option of (3) Angle Spade Anchors add 9 lbs. to the weight and \$28.00 to the price for the Tip-Back Anchor Pins (TB).
Options: For the TA option of (2) Angle Spade Tip-Back Anchors add 7 lbs. to the weight and \$24.00 to the price for the Tip-Back Anchor Pins (TB).
 For the TB-BD option of (1) Tip Back-Bolt Down Anchor Bracket use the same weight and price as for the Tip-Back Anchor Pins (TB) -for FSW-30 only.
 For the AL anchor option of (4) Angle Spade Anchors add 12 lbs. to the weight and \$40.00 to the price for the (4) "U" Anchor Pins (PA).



MULTILEVEL CAMPFIRE RING - L Series (Catalog Page 116)										
Four Level Adjustable Cooking Grate, flanged 3/16" plate steel firering and adjustment panels. Campfire Rings and Riser Platforms finished in high temp, non-toxic Black Enamel paint										
Model No.	Outside Diameter (in.)	Inside Diameter (in.)	Side Height (in.)	Cooking Area (sq. in.)	Standard: (2) Tip-Back "U" Anchor Pins (TB)		Optional: (2) Angle Spade Tip-Back Anchors (TA)		Optional: (1) Tip Back-Bolt Down Anchor Bracket (TB-BD)	
					Wt. (lbs.)	Price	Wt. (lbs.)	Price	Wt. (lbs.)	Price
L-32/6/◆	32	30	6-1/4	300	80	\$261.00	87	\$288.00	80	\$261.00
L-32/9/◆			9		99	\$323.00	136	\$349.00	99	\$323.00
L-32/11/◆			11		114	\$370.00	121	\$396.00	114	\$370.00



Replace ◆ in Model No. with TB for Standard (2) "U" Anchor Pins, TA for (2) Angle Spade Tip-Back Anchors, or TB-BD for a Tip Back-Bolt Down Anchor Bracket.

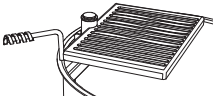

Model No.	Description	Wt. (lbs.)	Price
RL-35	Steel Riser Platform for L-32/6 firering, 33" x 34-3/8" x 16-1/8" high	150	\$412.00
RL-36	Steel Riser Platform for L-32/6 firering, 34" x 36" x 10-3/8" high	125	\$344.00
ANC1-4	Concrete Anchor Set for Steel Riser Platforms: (4) 1/2" x 3" heavy duty screw anchors	2	\$12.00

LARGE GROUP FIRERING - O Series (Catalog Page 116)								
One Level, Cooking Grate, grate tips back out of 1/4" plate steel firering, finished in high temp non-toxic Black Enamel paint								
Model No.	Inside Dimension (in.)	Side Height (in.)	Cooking Area (sq. in.)	Standard: (2) Tip-Back "U" Anchor Pins (TB)		Optional: (2) Angle Spade Tip-Back Anchors (TA)		
				Wt. (lbs.)	Price	Wt. (lbs.)	Price	
O-34/◆	34 x 40	6	510	120	\$367.00	127	\$393.00	

Replace ◆ in Model No. with TB for (2) "U" Anchor Pins or TA for (2) Angle Spade Tip-Back Anchors.

 SNOW LOAD RATED SWIVEL GRATE FIRERINGS - FSW/SL Series (Catalog Page 117)										
Single Level Cooking Grate withstands snow loads of over 569 lbs. per sq. ft. Laser cut from 1/4 in. steel plate, special channel brace welded inside the ring to reinforce the swivel tube. Meets ADA guidelines for one hand operation requiring less than 5 lbs. of force to move. Grate rotates 180° out of firing with handle never over the fire. Finished in high temp, non-toxic Black Enamel paint.										
Model No.	Outside Dia. (in.)	Inside Dia. (in.)	Side Ht. (in.)	Swivel Grate Cooking Area (sq. in.)	Wheelchair Accessible Height	Heat Shield Available	Anchor System		Wt. (lbs.)	Price
FSW/SL-30/7/TB	32	30	7-3/8	300	No	No	(2) Tip-Back "U" Anchor Pins (TB) (Optional: AL, TA, or TB-DB)		74	\$313.00
FSW/SL-30/9/TB	32	30	9			Yes			84	\$361.00
FSW/SL-30/11/TB	32	30	11-3/8					93	\$392.00	
FSW/SL-30/18/PA	32	30	16-7/8		Yes 	Yes	(3) "U" Anchor Pins (PA) (Optional: AL)		129	\$498.00
FSW/SL-30/24/PA	32	30	23-3/8					158	\$580.00	
FSWDW/SL-30/18/TB	32	26-3/8	17-3/8			No	(2) Tip-Back "U" Anchor Pins (TB)		196	\$731.00
Anchor Options: For the AL option of (3) Angle Spade Anchors add 9 lbs. to the weight and \$28.00 to the price for the Tip-Back Anchor Pins (TB). For the TA option of (2) Angle Spade Tip-Back Anchors add 7 lbs. to the weight and \$24.00 to the price for the Tip-Back Anchor Pins (TB). For the TB-BD option of (1) Tip Back-Bolt Down Anchor Bracket use the same weight and price as for the Tip-Back Anchor Pins (TB).										

 ACCESSIBLE FIRERINGS  (Catalog Pages 117 - 120)						Flanged 3/16" plate steel firerings except for LDW-36/18/TB, FSDW-30/18/TB, and FSWDW-30/18/TB Double Walled Firerings which have 1/8" plate steel outer ring and 3/16" plate steel inner fire wall, all finished in high temp, non-toxic Black Enamel paint			
Model No.	Outside Diameter (in.)	Inside Diameter (in.)	Side Height (in.)	Cooking Area (sq. in.)	Grate Adjustment	Anchor System		Wt. (lbs.)	Price
SNOW LOAD RATED SWIVEL GRATE on Accessible Firerings (Catalog Page 117) - Grate rated for 569 lbs. per sq. ft., Black Enamel painted									
FSW/SL-30/18/PA	32	30	16-7/8	300	Swivel	(3) "U" Anchor Pins (PA)		129	\$498.00
FSW/SL-30/24/PA	32	30	23-3/8	300	Swivel	(3) "U" Anchor Pins (PA)		158	\$580.00
FSWDW/SL-30/18/TB	32	26-3/8	17-3/8	300	Swivel	(2) Tip-Back "U" Anchor Pins (TB)		196	\$731.00
ACCESSIBLE FIRERINGS (Catalog Page 118 - 119)									
M-32/17/PA	32	30	16-3/8	300	Four Level	(3) "U" Anchor Pins (PA)		135	\$481.00
LDW-36/18/PA (Replaces LDW-36/18/TB)	36-1/2	31-3/4	17-3/8	300	Four Level	(3) "U" Anchor Pins (PA)		200	\$712.00
LDW-36/18/AL	36-1/2	31-3/4	17-3/8	300	Four Level	(3) Angle Spade Anchors (AL)		209	\$743.00
FS-30/18/PA	32	30	16-7/8	290	One Level, tip-over	(3) "U" Anchor Pins (PA)		117	\$418.00
FS-30/24/PA	32	30	23-3/8	290	One Level, tip-over	(3) "U" Anchor Pins (PA)		142	\$501.00
FSW-26/18/PA	26	24	16-7/8	300	Swivel	(3) "U" Anchor Pins (PA)		107	\$381.00
FSW-30/18/PA	32	30	16-7/8	300	Swivel	(3) "U" Anchor Pins (PA)		119	\$427.00
FSW-30/24/PA	32	30	23-3/8	300	Swivel	(3) "U" Anchor Pins (PA)		148	\$511.00
FSDW-30/18/TB	32	26-3/8	17-3/8	370	One Level, tip-over	(2) Tip-Back "U" Anchor Pins (TB)		186	\$664.00
FSWDW-30/18/TB	32	26-3/8	17-3/8	300	Swivel	(2) Tip-Back "U" Anchor Pins (TB)		186	\$674.00
STAINLESS STEEL ACCESSIBLE FIRERINGS (Catalog Page 120) - Stainless Steel firerings, Black Enamel painted Swivel Cooking Grate									
FSWS-30/18/PA	32	30	16-3/4	300	Swivel	(3) "U" Anchor Pins (PA)		94	\$722.00
FSWS-30/24/PA	32	30	23-1/4	300	Swivel	(3) "U" Anchor Pins (PA)		119	\$895.00
FSWS-30/18/AL	32	30	16-3/4	300	Swivel	(3) Angle Spade Anchors (AL)		97	\$753.00
FSWS-30/24/AL	32	30	23-1/4	300	Swivel	(3) Angle Spade Anchors (AL)		122	\$926.00

STAINLESS STEEL CAMPFIRE RINGS - FSWS & FXS Series (Catalog Page 120)									
Flanged 11 ga. Stainless Steel firerings, 1" flanged top edge. Firerings not painted. Single Level Swivel Cooking Grate meets ADA guidelines for one hand operation requiring less than 5 lbs. of force to move. Grate rotates 180° out of firing with handle never over the fire; finished in high temp, non-toxic Black Enamel paint.									
Model No.	Outside Diameter (in.)	Inside Diameter (in.)	Side Height (in.)	Swivel Grate Cooking Area (sq. in.)	Wheelchair Accessible Height	Standard: (3) black "U" Anchor Pins (PA)		Optional: (3) bolted-on, black Angle Spade Anchors (AL)	
						Wt. (lbs.)	Price	Wt. (lbs.)	Price
	32	30	7-1/4	300	No	59	\$469.00	62	\$500.00
			8-7/8			65	\$513.00	68	\$544.00
			11-1/4			74	\$578.00	77	\$609.00
			16-3/4			94	\$722.00	97	\$753.00
			23-1/4		119	\$895.00	122	\$926.00	
STAINLESS STEEL CAMPFIRE RINGS without Cooking Grate - FXS Series									
Flanged 11 ga. Stainless Steel firerings, 1" flanged top edge. Firerings not painted. No Swivel Cooking Grate.									
	32	30	7-1/4	NA -No Cooking Grate	No	35	\$313.00	38	\$344.00
			8-7/8			41	\$357.00	44	\$388.00
			11-1/4			50	\$422.00	53	\$453.00
			16-3/4			70	\$566.00	73	\$597.00
			23-1/4		94	\$737.00	97	\$768.00	
Replace ♦ in Model No. with PA for Standard (3) black painted "U" Anchor Pins, or AL for optional (3) bolt-on, black painted Angle Spade Anchors.									

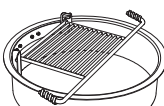
	REMOVABLE COOKING GRATE - Optional Grate for use with Stainless Steel Firerings (Catalog Page 120)				
	For FXS Series Stainless Steel Firerings - see Page 54. Single Level, Tip-over Cooking Grate, bolt-on hinge/pivot Mounting Bracket, fasteners included to bolt to the FXS Firerings				
	Model No.	Finish	Cooking Area (sq. in.)	Wt. (lbs.)	Price
I-RS	high temp, non-toxic Black Enamel paint	290	27	\$183.00	

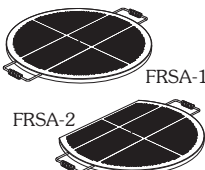
	FIRERING SPARK ARRESTORS (Catalog Page 121)					
	Model No.	Finish	Fits on these Firering Models	Diameter (in.)	Wt. (lbs.)	Price
	FRSA-1	high temp Black enamel	FS-30, FSDW-30, FX-30, FXS-30	34-3/4 ID, 35" OD, 43-3/8" OD at handles	19	\$147.00
	FRSAS-1	Stainless Steel			19	\$439.00
	FRSA-2	high temp Black enamel	FA-30, FSW-30, FSW/SL-30, FSW-30, FSWDW-30	34-3/4 ID, 35" OD, 43-3/8" OD at handles, 28" OD to flat side	17	\$147.00
	FRSAS-2	Stainless Steel			17	\$439.00
CK-1	Optional Chain Kit: Use to fasten the Spark Arrestor to the firering. 40" of Galvanized, 1/8" welded-link Steel Chain and (2) Galvanized, Equal Leg "S" Hooks				\$11.00	

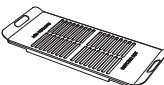
	DROP-IN COOKING GRATE (Catalog Page 122)						
	Model No.	Finish	Size (W x L -in.)	Fits in (Inside Dimension for Firerings and Fire Pits -in.)	Cooking Area (sq. in.)	Wt. (lbs.)	Price
	DIG-U4	high temp Black enamel	15-1/4 x 37-1/2	Round: 27 - 31	294	18	\$165.00
DIG/S-U4	Stainless Steel	Square: 23 - 27		16		\$205.00	

	FOLDABLE COOKING GRATE (Catalog Page 122)					
	Model No.	Finish	Size (in.)	Wt. (lbs.)	Price	
DIG-R35	high temp Black enamel	Folded: 34-1/2 wide x 18 long x 1" thick Unfolded: 34-1/2 wide x 35-1/4 long x 5/8 thick	23	\$201.00		

	CAMPFIRE RING COVERS (Catalog Page 123)				
	Model No.	Fits on these Firering Models	Inside Diameter (in.)	Wt. (lbs.)	Price
	CFA-30	FA-30	34-3/4	17	\$140.00
	CFS-30	FS-30			
	CFSW-30	FSW-30, FSW/SL-30, & FSW-30			
CFX-30	FX-30 & FXS-30 (no grate)				

	FIRERING LOCKOUT COVER (Catalog Page 123)			
	12 ga. steel plate, (2) welded on hooks and (1) padlocked-on hook, carrying handle cut into the cover, flange reinforced, non-toxic Black Enamel paint. Padlock and warning/informational decal included.			
	Model No.	Fits on these Firering Models	Wt. (lbs.)	Price
New! FLC/B-26	Fits on FA-26, FS-26, FSW-26, FX-26, and FSW-26/18 Firerings. Fits on FSW-26/18 Firering with Welded-on Heat Shields.		16	\$137.00
FLC/B-30	Fits on FA-30, FS-30, FSW-30, FSDW-30, FSW/SL-30, FX-30, FSW-30 and FXS-30 Firerings. Fits on FA-30, FS-30, FSW-30, FSW/SL-30 and FX-30 Firerings with Welded-on Heat Shields.		27	
The Lockout Covers will not work with the Model S5 Shelf attached. The Lockout Covers will work with the Model S5 Shelf bolted to the Welded-on Heat Shield. The Lockout Covers will not fit on the older, no longer available, Bolted-on Heat Shields and the Heat Shield would need to be removed.				

	FIRERING CLEAN OUT SHOVEL (Catalog Page 124)			
	Model No.	Description	Wt. (lbs.)	Price
FCS-1	Shovel formed from 14 ga. steel, 1/2" dia. steel handle with coiled spring grip	High temp, Black enamel paint finish	7	\$49.00

	UTILITY SHELF (Catalog Page 124)			
	Model No.	Size (in.)	Wt. (lbs.)	Add to Firering Price
S5	3/16 x 7-1/8 x 9-5/8	4	\$27.00	

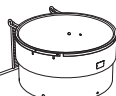
	HEAT SHIELDS (Catalog Page 124)				
	Fits on these Firering Models	Outside Diameter (in.)	Wt. (lbs.)	Add to Firering Price	
	M-32/17/PA	32-11/16	32	\$104.00	
	FA-30/11, FA-30/18	32-11/16			
	FS-30/11, FS-30/18/PA, FS-30/24/PA	32-11/16			
	FSW-26/18/PA	26-11/16	27		
FX-30, FSW-30, and FSW/SL-30: 11", 18", and 24" tall	32-11/16	32			

ANCHOR KITS

ANCHOR KITS (Catalog Page 126)								
Model No.	Products						Wt. (lbs.)	Price
	Benches	Bike Racks & Parking	Tables	Waste & Recycling	Amenities	Grills & Firerings		
BR-4HSA ¹ (4) 3/8" x 1-7/8" Bolt Sleeve	CLB, GBA-4, GBA-6, GBA3, GBA4 (2 Kits per Bench)	BR-6DS, BR-6SS, BR-12DS		SS/P-1 ⁴		HCB-1		\$10.00
ANC1-4 ¹ (4) 1/2" x 3" Screw Anchors	APB/P (1 Kit per leg), B30, B32, OWB/P, OWRB/P, PWB, PWRB	BR20, BR30, BR31, BR102, BR104, BR106	APT/P (1 Kit per leg)	M3, M7, CN-TR/P-52 ⁴	TB-1 ⁴ , APTX/P, ULT/P-1, ULT/P-2, ULT/P-4, ULT/P-3 (needs 2 Kits), MST/P-1R (needs 3 Kits)	B3, B7, B8, B17, B18 RL-35, RL-36	2	\$12.00
ANC1-4SS ¹ (4) 1/2" x 3" Stainless Steel Screw Anchors						B17S, B19S	2	\$64.00
ANC1-6 ¹ (6) 1/2" x 3" Screw Anchors	B30C, B32C, PWB3, PWRB3						3	\$17.00
ANC2-4 ¹ (4) 3/8" x 5" Screw Anchors	6' & 8' B302; 21' B304 (2 Kits per 21' Bench)	BR205SS, BR210SS, BR210DS, HRP-6,	T720	CN-R/SS2-36D, CN-Q/SS4-36D, CN-R/SP3-36D			2	\$11.00
ANC2-6 ¹ (6) 3/8" x 5" Screw Anchors	12' & 15' B303	BR220DS, HRP-8,					3	\$15.00
ANC3-4 ¹ (4) 3/8" x 3" Screw Anchors	PAB, SAB/P, PCB, PCXB, B40, B42, B60, B62, B76, B78, B80, B82, B100, B102, B120, B122, B130, B132, B400, B410, B412, 4', 5', & 6' BC3000, 4', 5', & 6' BC4000	HRP, SRP-3, SRP-5, SRP-7, SRP-9, SRP-11, BR310DS	6' & 8' T600 ⁴ , 6' & 8' T700, TQ700, 6' & 8' T702 (needs 3 Kits), TQ704 (needs 5 Kits), FCT-4 ⁴	CN-R/SS2-36, CN-R/SS3-36, CN-AMR-32, CN-AMQ-32, CN-R/R, CN-R/D, CN-Q/D-32/2, CN-Q-36, CN-R/SP2-32	6' & 8' XTX, P-22, P-23	GS-5 ⁴	2	\$10.00
ANC3-6 ¹ (6) 3/8" x 3" Screw Anchors	PAB3, SAB3/P, PCB3, PCXB3, B40C, B42C, B110, 8' BC3002, 8' BC4002	ORP, SRP-13, BR320DS	10' T600 ⁴		10' XTX		3	\$12.00
ANC4-4 ¹ (4) 1/2" x 3-3/4" Wedge Anchors	B90, B94						3	\$10.00
ANC5-4 ¹ (4) 1/2" x 5" Screw Anchors			PT/P, PQT/P, T400 TPT/P, CST/P (1 Kit per Post)	CN-VDT/P-32 ⁴ , BPRT1-36 ⁴	TB/P-2 ⁴ BPFL ⁴		2	\$14.00
ANC5-6 ¹ (6) 1/2" x 5" Screw Anchors				BPRT2-72 ⁴ , BPRT3-108 ⁴			3	\$20.00
ANC6-4 ¹ (4) 1/4" x 1-3/4" Screw Anchors	For use with ANG-3 and ANG-5 Strap Anchors below.							\$5.00
ANC11-3 ² (3) 3/4" x 17-3/4" Anchor Stakes		CSL-6, CSL-8 SB-6, SB-8					7	\$11.00
ANC12-3 ² (3) 3/4" x 24" Anchor Stakes		CSL-6, CSL-8 SB-6, SB-8					10	\$17.00

¹ Note: BR-4HSA, ANC1, ANC2, ANC3, ANC4, ANC5, and ANC6 Anchor Kits are for concrete surface installation only.

² Note: ANC11 and ANC12 Anchor Kits are for asphalt or ground surface installation only.

³ Note: Models Q3-2460, P-1000 and L-1500 Grills include (4) 1/2" x 6" J-bolts for embedding into concrete footings. (Install when concrete is poured.)

⁴ Note: Model SS/P-1 Smoker's Stack, Model CN-TR/P-52 Trash Receptacle, Model CN-VDT/P-32 Trash Can Cover, BPRT Series Bear Resistant Trash Receptacles, BPFL Series Bear Resistant Food Lockers, Model TB-1 Traffic Barrier, Model TB/P-2 Bollard Barricade, T600 Series Tables, FCT-4 Series Tables, and GS-5 Series Grill Stations each include a set of Screw Anchors. Order replacement Anchor Kits above.

ANCHOR SYSTEMS

ANGLE ANCHOR (Catalog Page 127)				
Formed Pregalvanized steel Angles; (2) 1/4" x 1" Hex Head Screws, (2) pairs recommended for each table or bench frame				
	Model No.	Description	Wt. (lbs.)	Price
	ANG-2	1 pair of Angles – for Recycled Plastic frames on RB Series Benches, and AT, AFT, WAT, and RT Series Tables	1/2	\$10.00

ANCHOR SYSTEMS ... continued on Page 57

RJ Thomas Mfg. Co., Inc.

P.O. Box 946 • Cherokee, Iowa 51012-0946 • ORDERS Toll Free: 800-762-5002 • FAX: 712-225-5796 • 712-225-5115

ANCHOR SYSTEMS ...continued

STRAP ANCHOR (Catalog Page 127)		Zinc Plated Steel Strap Anchors for steel tube table frames, (2) pair recommended for each table, anchor bolts not included –Optional Model ANC6-4 Anchor Sets are available, see the chart above		
	Model No.	Description	Wt. (lbs.)	Price
	ANG-3	1 pair of 2-3/8 I.D. Strap Anchors – for XT, XTH, WXT, WXTH, BTXG and T200 Tables	1/2	\$8.00
	ANG-5	1 pair of 1-5/8 I.D. Strap Anchors – for UT, UTH, UTK, BTUG, SQT, SQTk, T104K, and T100 Tables	1/2	\$8.00

SQUARE TUBE STRAP ANCHOR		Formed 10 ga. x 1-1/2" x 5" Pregalvanized Steel Strap Anchors; (2) pairs recommended for each table –Optional Model ANC3-4 Concrete Anchor Sets are available, see the chart on Page 56		
	Model No.	Description	Wt. (lbs.)	Price
	ANG-6	1 pair of Strap Angles – for 2-1/2" x 2-1/2" Square Tube Frames on WPTS and T720 Series Tables	1-1/2	\$10.00

DRIVE-IN GROUND ANCHORS (Catalog Page 127)		Drive deep into ground with heavy hammer and optional Drive Rod, wire cable attaches to table or bench and may be secured with optional padlock		
	Model No.	Description	Wt. (lbs.)	Price
	68-DB1	1,700 lb. capacity Anchor cabled with 5 Ft. of 1/8" galvanized wire cable	1	\$28.00
	88-DB1	7,000 lb. capacity Anchor cabled with 6 Ft. of 1/4" galvanized wire cable	2	\$44.00
	DS-68	3 ft. long 1/2" dia. Steel Drive Rod, large striking head, for Models 68-DB1	2	\$20.00
	DS-1	4 ft. long 3/4" dia. Steel Drive Rod tapered to 1/2", Heavy Duty, for Models 68-DB1, painted Black	4	\$83.00
	DS-2	4 ft. long 3/4" dia. Steel Drive Rod, for Models 88-DB1, painted Black	6	\$83.00
	PL-1	Padlock, Precision Brass Tumbler and Case, keyed alike, 2-1/2" overall		\$12.00

AUGER ANCHOR (Catalog Page 127)		Screw type Auger, 1/2" diameter steel shaft, 3-1/2" diameter auger, 30" long heavy link chain with cold shut		
	Model No.	Description	Wt. (lbs.)	Price
	AGS-1	Auger Anchor	5	\$34.00
	PL-1	Padlock, Precision Brass Tumbler and Case, keyed alike, 2-1/2" overall		\$12.00

FINISH, MATERIAL, and COLOR OPTIONS (Catalog Pages 52 – 57)

FINISH	Specifications	Product Availability	COLOR selections and Model Number Designations
Hot-Dip Galvanized Finish	Applied after fabrication and welding to ASTM-A123 specifications to maintain an average zinc coating of 2.0 oz. per sq. ft. of surface area.	Select bench and table frame components, lantern holders, trash receptacle holder components, bike racks, and some grill models.	Use "/G" in the model numbers. Example: XT/G-6UP for Hot-Dip Galvanized XT Series table frames.
Heat Resistant Black Enamel Paint	Silicone based paint is lead and chrome free and especially formulated for Pilot Rock. The non-toxic, matte (low gloss) black enamel paint is high heat resistant, capable of enduring temperatures exceeding 750 degrees.	Grills, firings, ULT series utility tables, shelves, grill covers, select grill accessories, and hot coal bins.	Use "/B" in the model numbers. Example: ULT/B-1 for a Black Enamel painted ULT Series Utility Table. Exceptions: grills and firings are normally finished in Black enamel paint and the model numbers do not include the "/B" designator.
Powder Coat Finish	Baked on, lead-free, TGIC polyester powder coat paint finish applied in a multi-step process of material preparation and finish application. Electrostatically applied and chemically bonded to the metal substrate in 430 degree industrial oven to a 3 mil thick coating.	Steel components on select benches, tables, lantern holders, trash receptacle holders, and bike racks.	For Steel Components use: "/CT" for Tan "/CU" for Blue "/CB" for Black "/CR" for Red "/CW" for Brown "/CY" for Yellow "/CN" for Green "/CA" for Gray "/CE" for Burgundy Example: UT/CN-6UP for UT table frames powder coated Green.
		Mill finish Aluminum Planks on select benches and tables. See Aluminum specifications on Page 58.	For Aluminum Planks use: "/AT" for Tan "/AU" for Blue "/AB" for Black "/AR" for Red "/AW" for Brown "/AY" for Yellow "/AN" for Green "/AA" for Gray "/AE" for Burgundy Example: XT/G-6AR for Aluminum planks powder coated Red on XT table frames.
Textured Powder Coat Finish	Semi-gloss, textured TGIC polyester powder coat paint finish with the same application process as above.	BPRT series bear resistant trash and recycling receptacles, BPFL series bear resistant food storage lockers, and FCT-4 series food court tables.	Use: "/CTT" for Speckled Tan "/CUT" for Blue "/CBT" for Black "/CNT" for Green "/CWT" for Brown Example: BPFL/CTT-30 for a Bear Resistant Food Locker with a Speckled Tan textured powder coat finish.

FINISH, MATERIAL, and COLOR OPTIONS ...continued on Page 58

RJ Thomas Mfg. Co., Inc.

P.O. Box 946 • Cherokee, Iowa 51012-0946 • **ORDERS Toll Free: 800-762-5002** • FAX: 712-225-5796 • 712-225-5115

FINISH, MATERIAL, and COLOR OPTIONS (Catalog Pages 52 – 57) ...continued

FINISH	Specifications	Product Availability	COLOR selections and Model Number Designations
Thermo-plastic Coating	UV-stabilized, PVC and Phthalate free, textured matte finish, colored polyethylene powder applied to steel components in a multi-step process of material preparation and finish application for superior adhesion. Fused and bonded to steel heated to 550 - 600 degrees and baked at high temperatures to cure the 35-40 mils thick coating. Finish has the highest rating of DNI -Does Not Ignite: does not support combustion during or after flame exposure.	Steel components on select benches, tables, trash receptacles, lids, and bike racks, including expanded steel, perforated steel, cut plate steel, steel strap, and formed steel channel.	Use: “/TB” for Black “/TU” for Blue “/TW” for Brown “/TA” for Gray “/TR” for Red “/TY” for Yellow “/TN” for Green “/TT” for Tan “/TO” for Orange “/TLG” for Light Green Example: B122/CB-4SP/TA for a B120 Series Contemporary Steel Bench with Gray Cut Steel Plate contour seat. For examples of Formed Steel Channel, Steel Strap, and Cut Steel Plate, and for material and color designations for components with V-Type and D-Type Expanded Steel, or H-Type and R-Type Perforated Steel, see the respective material sections on this page below and Page 59.

MATERIAL	Specifications	Product Availability	COLOR selections and Model Number Designations
Untreated #1 Southern Yellow Pine	Kiln dried, precision drilled, and all exposed edges removed to 3/8" radius.	2" x 10" planks for tables; 2" x 4" or 2" x 10" for various benches; and 2" x 4" slats for trash receptacle holders.	Use “UP” in the model numbers. Example: WXTH/G-8UP for Untreated Pine 2" x 10" Planks on a WXTH Series table.
Treated #1 Southern Yellow Pine	Pressure treated with wood preservative (no arsenic), kiln dried after treatment (KDAT), precision drilled, and all exposed edges removed to 3/8" radius.	2" x 10" planks for tables; 2" x 4" or 2" x 10" for various benches; and 2" x 4" slats for trash receptacle holders.	Use “TP” in the model numbers. Example: PCXB/G-6TP24 for Treated Pine 2" x 4" Slats on a portable CXB Series bench.
Construction Heart Redwood	Made from interior grain of American Redwood, precision drilled, and all exposed edges removed to 3/8" radius. This grade allows for knots up to 2-1/2" in diameter.	3" x 4" timbers only for B30, B40, B60, B80, B90, WB, WRB, OWB, and OWRB Series benches.	Use “CO” in the model numbers. Example: B42/CB-6CO for Construction Heart Redwood on a B40 Series surface mount bench.
Exotic Imported Hardwoods	Species may vary depending on availability and cost. Available only in 3" x 4" nominal dimension timbers for benches. Please inquire.	3" x 4" timbers only for B30, B40, B60, WB, WRB, OWB, and OWRB Series benches.	

Other Species of Lumber: Cedar, Fir, and Clear Redwood may be available when in stock –please inquire.

Aluminum 2" x 10" nominal Planks of 6063-T6 extruded Aluminum Alloy	Clear Anodized Finish to specification 204 R1.	Available on CXB, WMB, B300, AB, and APB Series benches; and on most rectangular and square tables as listed.	Use “AL” in the model numbers. Example: SCXB/G-8AL for Clear Anodized Aluminum planks on a CXB Series bench.
	Optional Powder Coat Finish on mill finish planks up to 12 ft. long.	Available on CXB, WMB, B300, AB, and APB Series benches; and on most rectangular and square tables as listed.	For optional Powder Coat finish model number designations see Finish section on Page 57.
100% Recycled Plastic	100% recycled high-density polyethylene molded into solid shapes corresponding to nominal lumber dimensions and other functional shapes. Solid color throughout and UV stabilizer for ultraviolet protection.	2" x 10" planks for tables; 2" x 4", 2" x 6", or 2" x 10" slats and planks for benches; 3" x 4" timbers for select benches and an APT table design; and 1" x 4" or 2" x 4" slats for trash and recycling receptacle holders.	Use: “PR” for Red “PY” for Yellow “PB” for Black “PU” for Blue “PD” for Weathered Wood “PC” for Cedar “PN” for Green “PA” for Gray “PW” for Brown Example: B110C/CB-6PU24 for a B110C Series Accessible Bench with Blue 2" x 4" Recycled Plastic.
	Recycled Plastic model number designation exceptions: For RB Series benches and RT and ART Series tables, drop the “P” from the above designations. Examples: RBB/Y-6B26 for an RBB Series Bench, RT/W-6C for an RT Series Table, or ART/B-8C for an ART Series Table. For AT, AFT, and WAT Series tables with Recycled Plastic drop the “P” from the above designations for the frame color after the “AT”, “AFT”, or “WAT” but use the usual letters for the top and seat colors. Example: AT/W-6PN for an AT Series Table.		
Formed Steel Channel	16 ga. Steel Plate formed to approximate 2" x 4" lumber dimensions, 16 ga. end caps and bracing, all-welded construction. Thermo-plastic Coated	Available on CXB, AB, APB, and WMB Series benches, and most steel frame rectangular tables.	Use “SC/T♦” in the model numbers. Example: UT/G-6SC/TR for a UT Series table with Red Formed Steel Channel table top and seats. Replace “/T♦” with other color designations for the Thermo-plastic Coating listed above.
Steel Strap	1/8" thick Steel Strap, all-welded construction. Powder Coat Finish	Available on B80, B90, and B120 Series flat and contour benches, on select trash receptacles, and P22 planters.	Use “SS” in the model numbers. Example: B121/CB-4SS/CY for a Contemporary Steel Series bench with Yellow Steel Strap flat seat. Replace “/CY” with other color designations for Powder Coat paint listed on Page 57.
	1/8" thick Steel Strap, all-welded construction. Thermo-plastic Coated	Available on CN-R/SS3-36 trash receptacles, and P23 planters.	Use “/T♦” in the model numbers. Example: P-23/TN for a planter with Green coating. Replace “/T♦” with other color designations for the Thermo-plastic Coating listed above.

FINISH, MATERIAL, and COLOR OPTIONS ... continued on Page 59

FINISH, MATERIAL, and COLOR OPTIONS (Catalog Pages 52 – 57) ...continued

MATERIAL	Specifications	Product Availability	COLOR selections and Model Number Designations
Cut Steel Plate	10 ga. Steel Plate, all-welded construction with pattern cut into the steel. Powder Coat Finish	Available on B80 and B90 Series flat and contour benches, and the CN-R/SP3-36D trash receptacle.	Use “ SP ” in the model numbers. Example: B92/CU-6 SP for an Oak Knoll Series bench with Blue Cut Steel contour. Cut Steel color is same as the frames and is designated by the “/CU”. Replace “/CU” with other color designations for Powder Coat paint listed on Page 57.
	10 ga. Steel Plate, all-welded construction with pattern cut into the steel. Thermo-plastic Coated	Available on B70 and B120 Series flat and contour benches, T Series round tables, and the CN-R/SP2-32 trash receptacle.	Use “ SP/T♦ ” in the model numbers. Example: T204/G-6 SP/TU for a T Series table with Blue Cut Steel table top and seats. Replace “/T♦” with other color designations for the Thermo-plastic Coating listed on Page 58.
Expanded Steel fabricated using 3/4 - #9 Expanded Steel with a short longitudinal stretch	D-Type Expanded Steel: Standard Duty table top and seat, and other component design for most common public applications. Thermo-plastic Coated	Available on select benches, most rectangular tables, round tables (not available on SQT or PQT Series square tables), and select trash receptacles.	Use: “ DB ” for Black “ DU ” for Blue “ DW ” for Brown “ DA ” for Gray “ DR ” for Red “ DY ” for Yellow “ DN ” for Green “ DT ” for Tan “ DO ” for Orange “ DLG ” for Light Green Example: T304/G-4 DU for a T300 Series table with Blue Expanded Steel table top and seats.
	V-Type Expanded Steel: designed with wider edge banding and more supports for heavier use and ❄️ Snow Load applications. Thermo-plastic Coated	Available on select benches, and most rectangular tables and square tables (only specified rectangular tables are snow load rated).	Use: “ VB ” for Black “ VU ” for Blue “ VW ” for Brown “ VA ” for Gray “ VR ” for Red “ VY ” for Yellow “ VN ” for Green “ VT ” for Tan “ VO ” for Orange “ VLG ” for Light Green Example: PAB/G-6 VW 10 for an AB Series bench with Brown 2" x 10" Expanded Steel planks.
Perforated Steel fabricated using 14 ga. steel with 9/16" dia. holes punched on 13/16" straight line centers	R-Type Perforated Steel: standard duty table top and seat, and other component design for most common public applications. Thermo-plastic Coated	Available on select benches, most rectangular tables, round tables (not available on SQT or PQT Series square tables), and select trash receptacles.	Use: “ RB ” for Black “ RU ” for Blue “ RW ” for Brown “ RA ” for Gray “ RR ” for Red “ RY ” for Yellow “ RN ” for Green “ RT ” for Tan “ RO ” for Orange “ RLG ” for Light Green Example: TPT/P/CY-8 RR for a TPT Series table with Red Perforated Steel table top and seats.
	H-Type Perforated Steel: designed with wider edge banding and more supports for heavier use and ❄️ Snow Load applications. Thermo-plastic Coated	Available on select benches, and most rectangular tables and square tables (only specified rectangular tables are snow load rated).	Use: “ HB ” for Black “ HU ” for Blue “ HW ” for Brown “ HA ” for Gray “ HR ” for Red “ HY ” for Yellow “ HN ” for Green “ HT ” for Tan “ HO ” for Orange “ HLG ” for Light Green Example: APB/G-8 HR 12 for an APB Series bench with Red 2" x 12" Perforated Steel planks.

ORDERING INFORMATION (Catalog Page 128)

- Please make out Purchase Orders and Payments to: **R. J. Thomas Mfg. Co., Inc.** R. J. Thomas Mfg. Co., Inc. is a small business.
- **GSA Contracts:** GSA Contracts are available for federal accounts. Contact Customer Service for Contract information.
- **PRICE:** All prices are F.O.B. Cherokee, Iowa. Prices subject to change without notice. Quantity discounts and freight allowance available.
- **TERMS:** Net due 30 days from date of invoice to those with established credit. First time orders and others: prepayment in full before shipment. Finance charges after 30 days. Payment by credit card is accepted by phone or online using:



- **FREIGHT:** Prepaid and added to the invoice, or third party billed. Weights listed are approximate and do not include packaging. Shipment will be made by the quickest, most economical and practical means possible. Call for freight estimate. A formal quotation can be furnished. Most products are shipped unassembled to minimize shipping costs. Detailed assembly instructions are included with fasteners. Shipments may be subject to additional charges such as residential delivery, lift gate, oversize shipment, re-consignment, metro delivery, and other fees.

Please Note: The customer is responsible for unloading the order from the freight truck (the driver is not required to help). This may mean arranging for a forklift to unload pallets or unbanding the order to unload by hand. This policy is customary under common freight carrier practices and not under the control of R. J. Thomas Mfg. Co., Inc.

- **LEAD TIMES:** Order as early as possible. Our usual lead times run **4 weeks**. Busy season lead times can reach **6 to 8 weeks**. When you order early we can better arrange delivery to meet your needs.
- **SPECIFICATIONS:** Specifications were in effect when printing this catalog. Since product improvements are always being made, we reserve

the right to change designs, specifications, and discontinue products without notice. Where changes have been made, revised products will be shipped unless specific arrangements have been made to the contrary.

- **LUMBER POLICY:** Pressure treatment of lumber provides long-lasting resistance to termites and decay. Due to the non-homogeneous nature of wood and the climatic differences across the country, it is recommended that a water repellent be applied to treated or untreated lumber to protect against season checks, twisting and splintering. (If further painting or staining is desired, check the instructions for the brand of water repellent used.)
- **ADDITIONAL INFORMATION:** Contact us if you require additional information on product specifications, assembly, or installation. Specification Bulletins are available on our web site.
- **MODIFICATIONS:** If a desired combination of features, materials, options, or accessories is not covered in our catalog, contact us and we will advise as to availability and price. We have custom design/fabrication capabilities for volume projects.
- **RETURN POLICY:** No returns are accepted without prior approval. Call Customer Service for a Return Authorization (RA) number. Requests must be made within (30) days of receipt of the product. No returns will be accepted after (30) days. Products must be returned in the original packaging, must not be used or damaged, and must be in resalable condition. Returns may be subject to a restocking charge. Return freight must be prepaid.
- **ORDER CANCELLATION:** Orders for standard products may be cancelled prior to shipment. Conditions will vary. Orders cancelled after shipment are subject to return freight charges and restocking fees. Any product that includes custom features or modifications (from our standard product designs) cannot be returned for refund or credit. Any order that includes custom signage (in any form) cannot be cancelled after we receive final design approval. Products with custom signage cannot be returned for refund or credit. All sales are final on customized products.

SHIPPING INFORMATION (Catalog Page 128)

- **FREIGHT SHIPPING METHOD:** Most of the time we will ship by truck freight (see below), but some items can ship by UPS or FedEx. We will tell you how your products will ship in our Quote Response and Order Acknowledgement.

NOTE: freight quotes are valid for (14) days from the quotation date. After (14) days it will be necessary to confirm/requote the freight cost.

- **TRUCK FREIGHT:** Unless other method is specified, all Freight Estimates are calculated using commercial truck freight shipping to a BUSINESS or COMMERCIAL ADDRESS able to receive and unload packaged or palletized freight. Someone must be available to inspect and sign for the freight. The truck driver is not required to unload the freight, so the ship to address must have the personnel or machines to unload the freight.
- **ADDITIONAL FREIGHT SERVICES:** If you require additional freight services, such as pre-notification, lift gate or inside delivery, there may be EXTRA CHARGES if these services are available at your destination. You must contact our Customer Service Dept. for information on costs and availability of these additional services PRIOR TO PLACING YOUR ORDER.

THANK YOU for your order: If you have any additional questions, please contact Customer Service at 1-800-762-5002 (or 712-225-5115) or e-mail to customerservice@rjthomas.com. Thank you for your interest in our Pilot Rock products.

- **WHEN YOUR FREIGHT ARRIVES:**

Before signing the Carrier Freight Bill:

- #1) Make a close visual inspection of all pallets, boxes, cartons or crates for any visible damage.
- #2) Note any damage or shortage on the face of the Receiving Slip before you sign - BE SPECIFIC. Take photos if possible.
- #3) Retain one copy of the Receiving Slip and notify our office immediately by calling 1-800-762-5002.

FAILURE TO FOLLOW THESE STEPS WILL RELEASE THE CARRIER FROM ANY RESPONSIBILITY FOR LOSS OR DAMAGE.

If concealed damage or any shortages are discovered after unpacking, contact our Customer Service Dept. immediately at 1-800-762-5002. Take photos of the packaging and damaged items. You have (1) business days to report any damage or missing items to R. J. Thomas Mfg. Co.

ASSEMBLY: Picnic tables, benches, some trash receptacle holders, and some bicycle racks are shipped unassembled, with assembly required. Assembly hardware is included, and holes are pre drilled. Grills and campfire rings are shipped mostly assembled, but some minor assembly and installation are required. Prices DO NOT include assembly or installation.

PRODUCT WARRANTY (Catalog Page 129)				
TERM	PRODUCT	OTHER INFORMATION	REQUIREMENTS	EXCLUSIONS
LIFETIME	Picnic Table Frames: UT, UTH, XT, XTH, WXT, WXTH	Original Owner Only	All products must: 1) be assembled and installed according to manufacturer's specifications and instructions. 2) be properly maintained 3) not have been altered by the addition or deletion of parts, or modified in any other manner.	Vandalism. Damage caused by incorrect assembly, installation, application (use), or negligence. Natural or man-made disasters. Cosmetic changes due to weathering – including paint fading, discoloration of wood, or color fading or spotting of coated steel and recycled plastic products caused by exposure to natural elements or chemicals. Scratches, dents, or marring caused by normal use and public exposure. Season checks, twisting, or splintering of wood caused by climatic differences or lack of proper maintenance. Loss or damage in transit while product is responsibility of carrier High heat paint subject to overly built fires. Steel warpage caused by fires of excessive size or duration Premature rust-through of grill boxes due to improper cleaning or maintenance, and fire rings buried in the ground. Premature rusting or discoloring caused by corrosive environment or while in ocean transit. Damage caused by animals or wildlife.
ONE YEAR	Powder Coat, Enamel, and High Heat Paints; Lumber; Trash and Recycling Lids and Liners; Plaques; Decals; Resin Fill; Umbrellas; Pet Waste Stations; FSW Swivel Grate	No Warranty on Lumber shipped outside the United States. Water Repellent recommended on Lumber.		
FIVE YEARS	Thermo-plastic Coating	Limited and Prorated Warranty on coating material against defects when subjected to normal use and proper maintenance.		
	Picnic Table Frames (those not included in Lifetime Warranty), Park Bench Frames, Steel and Aluminum Bench and Table seat/top Structures, Recycled Plastic Components, Bike Racks, TRH and TRQ Frames, Steel Trash Receptacle and Planter Structures, Pedestal Mounts, Tissue Holders, all Grills, Hot Coal Bins, Utility Tables, Steel Campfire Rings, Lantern Holders, Food Lockers, Kolorcans	Recycled Plastic warranty applies only to components that have been cut, drilled, or routed by the manufacturer. This warranty does NOT cover plastic purchased in raw stock form by the customer and cut, drilled, or routed by the customer for custom application. Recycled Plastic and Thermo-plastic coated components include a UV stabilizer to retard effects of natural exposure. We cannot warrant "fading" or surface "contamination" due to extreme variations in levels of exposure and in the definition of "fading".		
FIFTY YEARS	Recycled Plastic	Material decomposition only.		
Warranty claims must be filed within the warranty period and must include a copy of the invoice or the purchase order.				
Except as specifically stated herein, all warranties (expressed or implied) are hereby excluded. This Warranty excludes any liability, consequential damages, or related costs.				



**California Customers
Please be advised...**

This notice is pursuant to California Health and Safety Code section 25249.5 et seq. ("Prop 65") and one of its enabling regulations at 27 CCR § 25600.2(b) (effective 30 August 2018). California law requires any company to declare if their products contain certain substances, as so listed on <https://oehha.ca.gov/proposition-65/proposition-65-list> and those products are sold in California.



PRODUCTS USING STEEL WARNING:

Some metal items may contain components or synthetics known to the State of California to cause cancer, birth defects, or reproductive harm. These elements include but are not limited to Chromium, Cobalt, Lead, and Nickel.

PRODUCTS USING LUMBER WARNING: (*Benches, Picnic Tables, Trash Receptacles*)

Drilling, sawing, sanding or machining wood products can expose you to wood dust, a substance known to the state of California to cause cancer. Avoid inhaling wood dust or use a dust mask or other safeguards for personal protection.

GRILL & CAMPFIRE RING WARNING:

This product can expose you to Carbon Monoxide, which is a combustion by-product known to the State of California to cause birth defects or other reproductive harm. For more information go to www.P65Warnings.ca.gov. Carbon monoxide can replace oxygen in the bloodstream. Reduced levels of oxygen during pregnancy can affect development of the baby's brain. Carbon monoxide is a colorless, odorless, and poisonous gas that is formed during the combustion of various fuels in park grills and campfire rings – including propane, wood, and charcoal. The exposure is not from the grill or the campfire ring, but from the fuel used. Exposure occurs by breathing air that contains carbon monoxide.

To reduce exposure to carbon monoxide: Ensure that grills and campfire rings are installed correctly outdoors and maintained properly. Never use charcoal or propane grills or barbecues, or campfire rings indoors.

For any questions concerning Proposition 65 refer to:

<https://oehha.ca.gov/proposition-65/law/proposition-65-law-and-regulations>

RJ Thomas Mfg. Co., Inc.