



*ECSFB-2640 Smoker Firebox Conversion kit
for Model EC grills.*



Model ECSFB-2640 assembly parts ship in one box.

SPECIFICATIONS:

- Model ECSFB-2640 firebox kit will convert your Pilot Rock Model EC-26 or EC-40 charcoal grill into a smoker with an offset firebox and a manifold to deliver consistent and even smoke and heat into the covered grill.
- Draft vents in the firebox and in the covered grill housing allow you to control the draft.
- Firebox conversion kit can be installed permanently, or removed and installed again as desired, with only one bolt.
- All steel construction, using 10 ga., 7 ga. and 14 ga. steel, angle iron and steel bar.
- Firebox handles are constructed from 5/8" dia. A-36 steel bar and provided with a substantial spring grip handle suitable for use by the public made from 1/8" x 1/2" steel flat bar (not wire springs).
- Entire unit is finished in high temperature, heat resistant, nontoxic black enamel.
- Firebox door closes securely with one latch handle.
- Ash pan pulls out for easy cleaning removal.
- Expanded steel firebasket for charcoal or wood.
- Quality construction throughout. Made in the USA.
- Ships in one box. Weight = 88 lbs. Assembly required.
- Grill base post installation: When using the ECSFB-2640 with your EC covered grill, we recommend the standard B2 embedded post installation, or the optional B14 caster base. Both will provide a stable platform for your grill and smoker.
- **Smoker firebox conversion kit includes:**
 - 1.8 cu. ft. firebox, sectional manifold, expanded steel fire basket for charcoal or wood, ash removal pan, high temp Nomex gasket smoker seal for grill cover, a thermometer for grill cover (installation is optional, requires drilling a hole), all fasteners for assembly.
- Model ECSFB-2640 smoker firebox conversion kit can be installed in existing EC grills in use, or purchased with new EC grills.
- The EC covered grill firebox is not insulated. You may need to keep a larger fire burning to maintain the desired interior air temperature, especially in colder weather.
- Before using your EC covered grill and Smoker Firebox Conversion Kit for the first time, you must season all components by building a fire and maintaining a smoker-level interior temperature for several hours.
- Cooking with a smoker is usually a very personal and passionate endeavor. Therefore, we choose not to make suggestions on what to smoke, what fuel to use, how long a cut of meat should be smoked, etc. If you are a practiced bbq smoker, then you can continue to follow your preferred recipes, temperatures, and times. If you are new to smoking, then we suggest you educate yourself about best practices with research on the internet, smoking cookbooks, or other smoking enthusiasts.

RJ Thomas Mfg. Co., Inc.

PO Box 946 • Cherokee, IA 51012-0946 • PH: 712-225-5115 • 800-762-5002 • FAX: 712-225-5796
E-mail: pilotrock@rjthomas.com • Web Site: <http://www.pilotrock.com>

© 2017 RJ Thomas Mfg. Co., Inc. PILOT ROCK[®] Park Products is a registered trademark of RJ Thomas Mfg. Co., Inc.

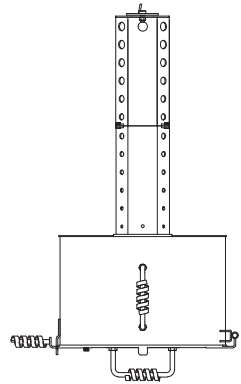

ECSFB-2640 Smoker for EC-26

TOP VIEW

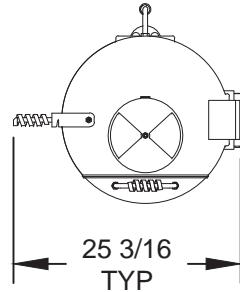

SIDE VIEW

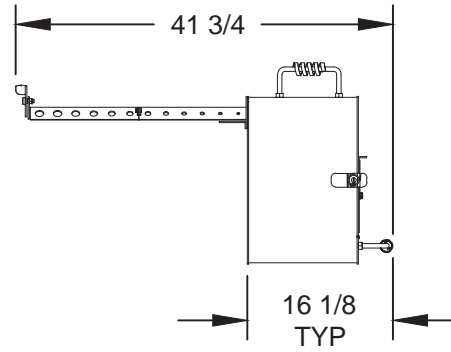

ECSFB-2640 Smoker for EC-26

FRONT VIEW

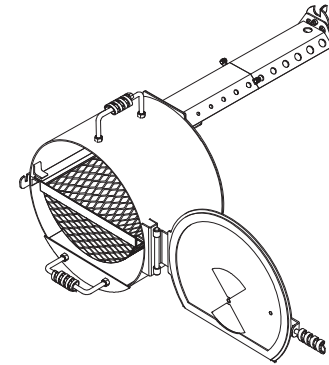

ECSFB-2640 Smoker for EC-26

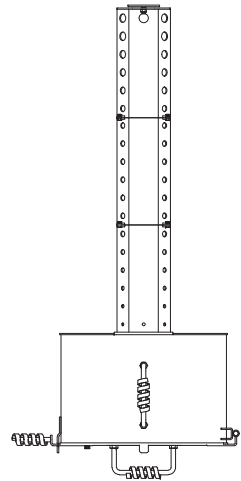

ECSFB-2640 Smoker for EC-40

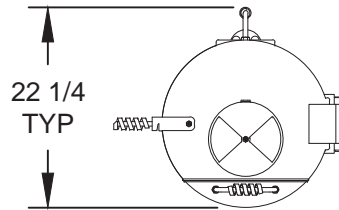

ECSFB-2640 Smoker for EC-40

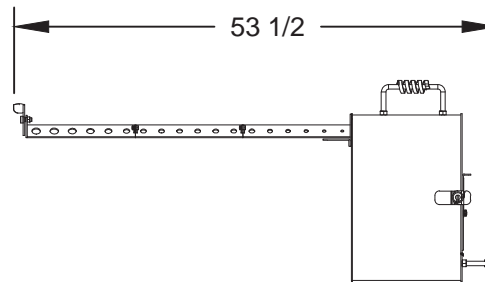

ECSFB-2640 Smoker for EC-40

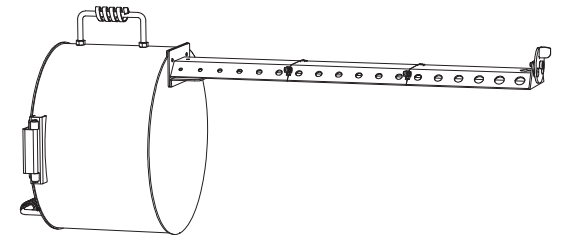

ALL DIMENSIONS IN INCHES

RJThomas Mfg. Co., Inc.
P.O. Box 946 • Cherokee, IA 51012-0946

DRAWN BY
MFI

TITLE MODEL ECSFB-2640 Smoker Kit for model EC-26 and EC-40 cover grills.

DATE 7-20-16

DWG. NO. **AI-2086**